

COMMERCIAL ELECTRIC WATER HEATERS



500 Tennessee Waltz Parkway
Ashland City, TN 37015

**MODELS DSE-5 THRU DSE-120
SERIES 100 and 102**

**INSTALLATION CONSIDERATIONS - PRE SERVICE
CHECKS - WATER HEATER CONSTRUCTION -
OPERATION & SERVICE - TROUBLESHOOTING**



SERVICING SHOULD ONLY BE PERFORMED BY A QUALIFIED SERVICE AGENT.

COMMERCIAL ELECTRIC WATER HEATER

SERVICE MANUAL

TABLE OF CONTENTS

INTRODUCTION	2	LWCO (Low Water Cut Off)	47
Qualifications	2	Powered Anode Rod	48
Service Warning	2	Electronic Controls	49
Tools Required.....	3	CCB - Central Control Board.....	50
INSTALLATION CONSIDERATIONS	4	CCB Socket & Wiring Terminal Identification	51
Closed Water Systems	4	CCB Enable Disable Circuit(s) Test.....	53
Thermal Expansion.....	4	Checking Power And Ground To The CCB	54
Electrical Requirements.....	5	UIM - User Interface Module	55
PRE SERVICE CHECKS.....	6	ELECTRONIC CONTROL SYSTEM	56
Service Precautions.....	5	Heating Element Operation	56
WATER HEATER CONSTRUCTION	7	Control System Features.....	57
5 - 20 Gallon Models	8	Control System Navigation	57
30 - 120 Gallon Models	9	The Desktop Screen.....	58
OPERATION & SERVICE.....	10	Status Icons.....	59
Principles of Electricity.....	10	Operating States.....	60
Single And Three Phase Power	12	Control System Menus.....	60
Checking Single Phase Power	13	Temperatures Menu.....	61
Checking Three Phase Power.....	14	Temperature Settings	62
Fuses	15	Heater Status Menu.....	63
Heating Elements	16	Economy Mode Setup Menu	64
Heating Element Construction.....	16	Setpoint Adjustment Value	65
Six and Three Wire Heating Elements	17	Time Clock Settings	66
Single Phase Element Wiring.....	18 - 19	Daily Operating Mode Settings.....	67
Three Phase Element Wiring.....	20 - 22	Alarm Output Setup Menu	68
Heating Element Ratings & Configurations	23	Display Settings Menu.....	69
Heating Element Amperage Tables	24	Heater Information Menu.....	70
Heating Element Amperage Test.....	25	Current Fault/Alert Menu	71
Heating Element Voltage Test	26	Fault History Menu	71
Heating Element Resistance Tables.....	28	Fault Occurrence Menu	71
Heating Element Resistance Test.....	29	Restore Factory Defaults Menu.....	72
Heating Element Ground Test	30	TROUBLESHOOTING.....	73
Replacing Heating Elements	31	Common Service Problems.....	73
Heating Element Sensors	32	Control System Diagnostics	74
Element Sensor Operation	33	Fault Conditions	74
Contactors	34	Alert Conditions	74
Contactor Configurations.....	35	Resetting The Control System	74
Contactor Inspection.....	36	Control System Unresponsive	74
Contactor Coil Voltage - At Contactor.....	37	UIM Display Is Blank	74
Contactor Coil Voltage - At CCB.....	38	UIM Is Inoperable	75
Transformers	39	Heating Cycle Disabled	75
120 VAC Control Circuit Transformer Wiring.....	39 & 40	Fault & Alert Messages	76
120 VAC Control Circuit Transformer Test.....	41	No Current Detected	76
24 VAC Transformer Test	42	Temp Probe Open	77
Immersion Temperature Probe	43	Temp Probe Short	77
Temperature Sensor Resistance Test.....	44	Energy Cut Out (ECO)	78
Temperature Sensor DC Voltage Test	45	LWCO Fault	79
ECO Continuity Test	45	No Anode Current	80
ECO Voltage Test	46		

INTRODUCTION

This Service Manual is designed to be an aid in servicing and troubleshooting the commercial electric water heater models listed on the cover. The instructions, illustrations and procedures contained in this manual are used to verify proper operation and to diagnose and repair common service problems.

This manual does not replace or supersede the Instruction Manual that came with the water heater. Always refer to the Instruction Manual that came with the water heater for complete installation instructions. If the Instruction Manual is not available copies can be obtained from the manufacturers web site or by calling the technical support phone number shown on the back cover of this manual.

Review the Common Service Problems on page 73 prior to performing any service procedures.

QUALIFICATIONS - QUALIFIED SERVICE AGENT

Servicing the products referenced in this manual requires ability equivalent to that of a Qualified Agency (as defined by ANSI below) in the field involved. Installation skills such as plumbing, electrical supply are required in addition to diagnostic and electrical testing skills when performing service.

ANSI Z223.1 2006 Sec. 3.3.83: "Qualified Agency" - "Any individual, firm, corporation or company that either in person or through a representative is engaged in and is responsible for (a) the installation, testing or replacement of gas piping or (b) the connection, installation, testing, repair or servicing of appliances and equipment; that is experienced in such work; that is familiar with all precautions required; and that has complied with all the requirements of the authority having jurisdiction."

SERVICE WARNING

If you are not qualified (as defined by ANSI above) and licensed or certified as required by the authority having jurisdiction to perform a given task do not attempt to perform any of the service, diagnostic or troubleshooting procedures described in this manual. If you do not understand the instructions given in this manual or do not feel confident in your abilities to perform a given task do not attempt to perform any procedures outlined in this manual.

IMPORTANT SERVICE REMINDER

When performing any troubleshooting step outlined in this manual always consider the wiring and connectors between components. Perform a close visual inspection of all wiring and connectors to and from a given component before replacement. Ensure wires were stripped before being crimped in a wire connector. Ensure wires are crimped tightly in their connectors. Ensure connection pins in sockets and plugs are not damaged or worn. Also ensure plugs and sockets are mating properly and providing good contact.

Failure to perform this critical step or failing to perform this step thoroughly often results in needless down time, unnecessary parts replacement, and customer dissatisfaction.

INSTRUCTION MANUAL

Have a copy of the Instruction Manual that came with the water heater on hand for the correct model water heater you are working with before servicing.

Installation information given in this Service Manual **IS NOT** a complete installation instruction. Installation information covered in this Service Manual has a limited focus as it applies to servicing. This Service Manual does not replace or supersede the Instruction Manual that came with the water heater. Always refer to the Instruction Manual that came with the water heater for complete installation instructions.

If the Instruction Manual is not on hand copies can be obtained from the manufacturers web site or by calling the technical support phone number shown on the water heater labeling and the back cover of this Service Manual.

TOOLS REQUIRED

- Instruction Manual that came with the water heater.
- All tools common to installation and service of commercial water heaters such as hand tools, torch, pipe wrenches etc.
- Electrical switch lock out device - used to secure disconnect switches/breaker panels while servicing.
- Insulated fuse puller(s).
- Adhesive numbered/colored wire markers - 3M Scotch Code SDR0-9 Numbered Wire Markers; 3M Scotch Code STD-C Colored Wire Markers or equivalent.
- Volt-Ohm Multi Meter - recommend Fieldpiece HS36, Fluke 187, UEI model DL289 or equivalent capable of measuring:
 - AC Voltage up to 600 VAC
 - DC Voltage up to 24 VDC
 - Ohms up to 2,000,000 ohms
- AC amp meter - recommend UEI model DL289 or equivalent capable of measuring:
 - AC amperage up to 400 amps

INSTALLATION CONSIDERATIONS

Installation information given in this Service Manual **IS NOT** a complete installation instruction. Installation information covered in this Service Manual has a limited focus as it applies to servicing. This Service Manual does not replace or supersede the Instruction Manual that came with the water heater. Always refer to the Instruction Manual that came with the water heater for complete installation instructions.

If the instruction Manual that came with the water heater is not on hand copies can be obtained from the manufacturers web site or by calling the technical support phone number shown on the water heater labeling and the back cover of this Service Manual.

CLOSED WATER SYSTEMS

Water supply systems may, because of code requirements or such conditions as high line pressure, among others, have installed devices such as pressure reducing valves, check valves, and back flow preventers. Devices such as these cause the water system to be a closed system.

Virtually all commercial and most residential water supply systems are closed systems today. Closed water systems will experience thermal expansion which, if not controlled with a properly installed and sized thermal expansion tank, can cause premature failure (leakage) of the water heater. Water heater failure (leakage) on closed systems where there is not a thermal expansion tank installed is not covered under the limited warranty.

THERMAL EXPANSION

As water is heated, it expands (thermal expansion). In a closed system the volume of water will grow when it is heated. As the volume of water grows there will be a corresponding increase in water pressure due to thermal expansion. Thermal expansion can cause premature tank failure (leakage). **This type of failure is not covered under the limited warranty.** Thermal expansion can also cause intermittent temperature-pressure relief valve operation: water discharged from the valve due to excessive pressure build up. **This condition is not covered under the limited warranty.** The temperature-pressure relief valve is not intended for the constant relief of thermal expansion.

A properly sized thermal expansion tank should be installed on all closed systems to control the harmful effects of thermal expansion.

ELECTRICAL REQUIREMENTS

Grounding

Review the electrical ground requirements given in the Instruction Manual that came with the water heater and ensure the water heater has been properly grounded.

The water heater must be grounded in accordance with the National Electric Code and/or local codes. These codes must be followed in all cases.

The water heater must be connected to a grounded metal, permanent wiring system; or an equipment grounding conductor must be run with the circuit conductors and connected to the equipment grounding terminal or lead on the water heater.

Service Note: The water heaters covered in this manual are equipped with electronic controls that may experience erratic operation if the water heater is not properly grounded. These water heaters are also equipped with a LWCO (low water cut off). Some models will also be equipped with a powered anode rod. LWCO devices and powered anode rods require an adequate earth ground to work properly. See pages 47 and 48.

Power Supply

Review the electrical requirements listed on the water heater's rating label and in the Instruction Manual that came with the water heater. Ensure the branch circuit supplying power to the water heater is within these requirements and properly connected.

Ensure the power supply phase (single or three phase / 1Ø, 3Ø) and power supply voltage match the water heater's rating label. Some of the commercial electric water heater models covered by this Service Manual are phase convertible. Voltage and KW conversions ARE NOT permitted.

PRE SERVICE CHECKS

WIRING CONNECTIONS

With the power supply to the water heater turned off ensure the wiring connections are properly tightened to all components including: high voltage terminal blocks, fuse blocks, contactors and transformers.

Loose connections at any connection point will cause increased amperage and excessive heat which can damage wiring and components. Whenever worn or damaged wiring and components must be replaced ensure all wiring connections are properly tightened before putting the water heater back in service.

SERVICE PRECAUTIONS

- 1 **DO NOT** energize the branch circuit supplying power to the water heater or test the water heater electrical system before the water heater is completely filled with water. Read the start up procedures in the Instruction Manual that came with the water heater.
- 2 Be sure to turn off power and use a lock out device at the branch circuit power supply disconnect switch or breaker when servicing the electrical system of the water heater. Never touch electrical components with wet hands or when standing in water.
- 3 When replacing heating elements ensure they are rated at the correct voltage and KW for the water heater being serviced see pages 23 and 31.
- 4 When replacing fuses use an insulated fuse puller to remove and install fuses. Always use the correct size for the circuit. See the Instruction Manual that came with the water heater for fuse size requirements. See page 15 in this manual.
- 5 Using an AC volt meter measure the branch circuit power supply voltage to the water heater. Ensure the measured voltage of the branch circuit supplying power to the water heater matches the water heater's rating label - see pages 12 - 14.
- 6 Ensure the phase of the branch circuit supplying power to the water heater matches the water heater's rating label. Some water heater models covered by this Service Manual are phase convertible. Some models are not phase convertible. See the Instruction Manual that came with the water heater for more information on phase conversions.
- 7 The water heaters covered by this manual have a multi tap control circuit transformer. This is a step down transformer that outputs 120 VAC (secondary winding) which is used to power the electronic control system and energize the contactor coils. The transformer can accommodate different power supply voltages and has multiple input voltage connections or "taps." Ensure the input supply voltage (primary winding) wiring to the transformer is connected properly. See the Instruction Manual that came with the water heater and pages 39 & 40 in this manual for more information.

Service Note - Contactor Chatter: Incorrect supply voltage wiring to the multiple tap 120 VAC Control Circuit Transformer will cause low/high output voltage from the transformer. This can cause contactors to open and close their contacts rapidly (contactor chatter) and result in permanent damage to the contactors. See pages 39 & 40.

WATER HEATER CONSTRUCTION

Electronic Controls

The water heaters covered in this Service Manual are equipped with an electronic control system - see page 56. The control system senses temperature electrically from an **Immersion Temperature Probe**. The probe is installed in a threaded opening in the storage tank (wet well) and senses water temperature directly. As the stored water temperature rises and falls the control system de-energizes and energizes heating elements indirectly using electromagnetic contactors. The control system energizes the electromagnetic contactor's (120 VAC) coil causing the switch contacts of the contactor to close which in turn supplies power to the heating elements - see pages 34 - 38.

Heating Element Configurations

Depending on tank size and how they were ordered from the factory the water heaters covered in this Service Manual may be equipped with 1 to 5 electric heating elements. Total input KW ranges from 3KW to 90KW. The water heaters covered in this manual are available in storage tanks sizes from 5 to 120 gallons.

Power Conversions

Other than power supply phase conversions on some models the water heaters covered in this Service Manual **cannot be field converted**. Voltage and KW conversions ARE NOT permitted. See the Instruction Manual that came with the water heater for more information. If the Instruction Manual is not available copies can be obtained from the manufacturers web site or by calling the technical support phone number shown on the water heater labeling and the back cover of this Service Manual.

WATER HEATER CONSTRUCTION

5 - 20 GALLON MODELS

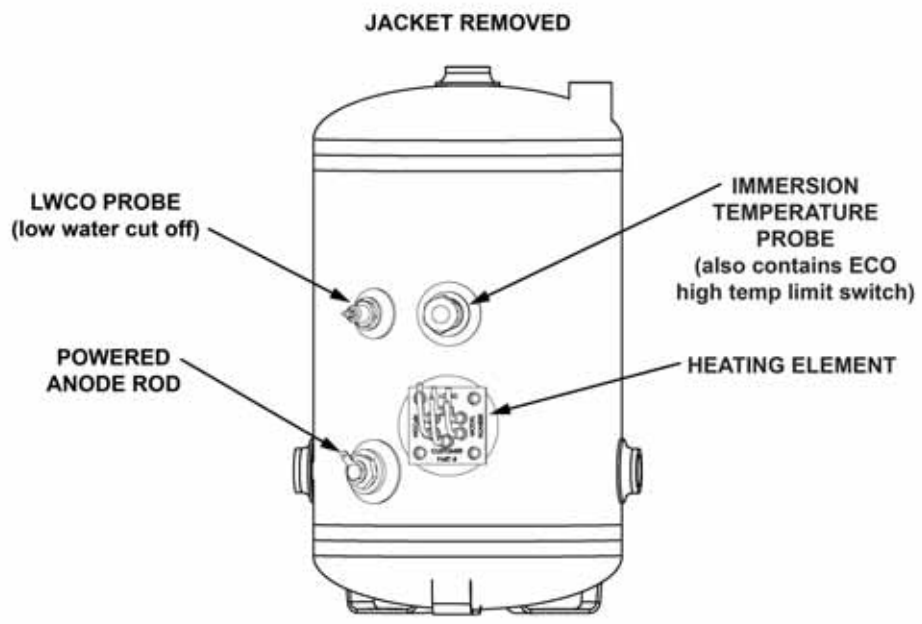
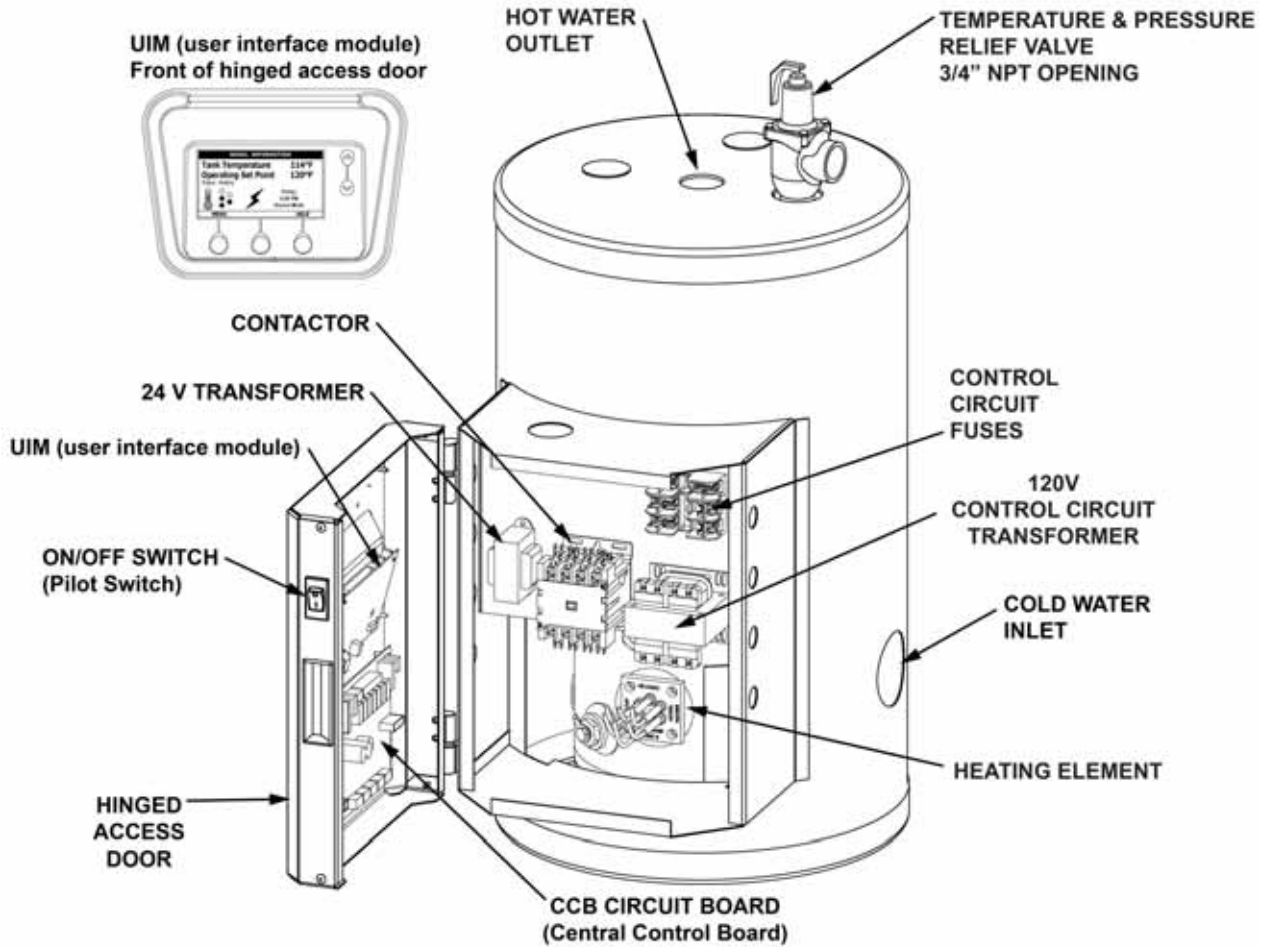

Figure 1

Servicing should only be performed by a Qualified Service Agent

30 - 120 GALLON MODELS

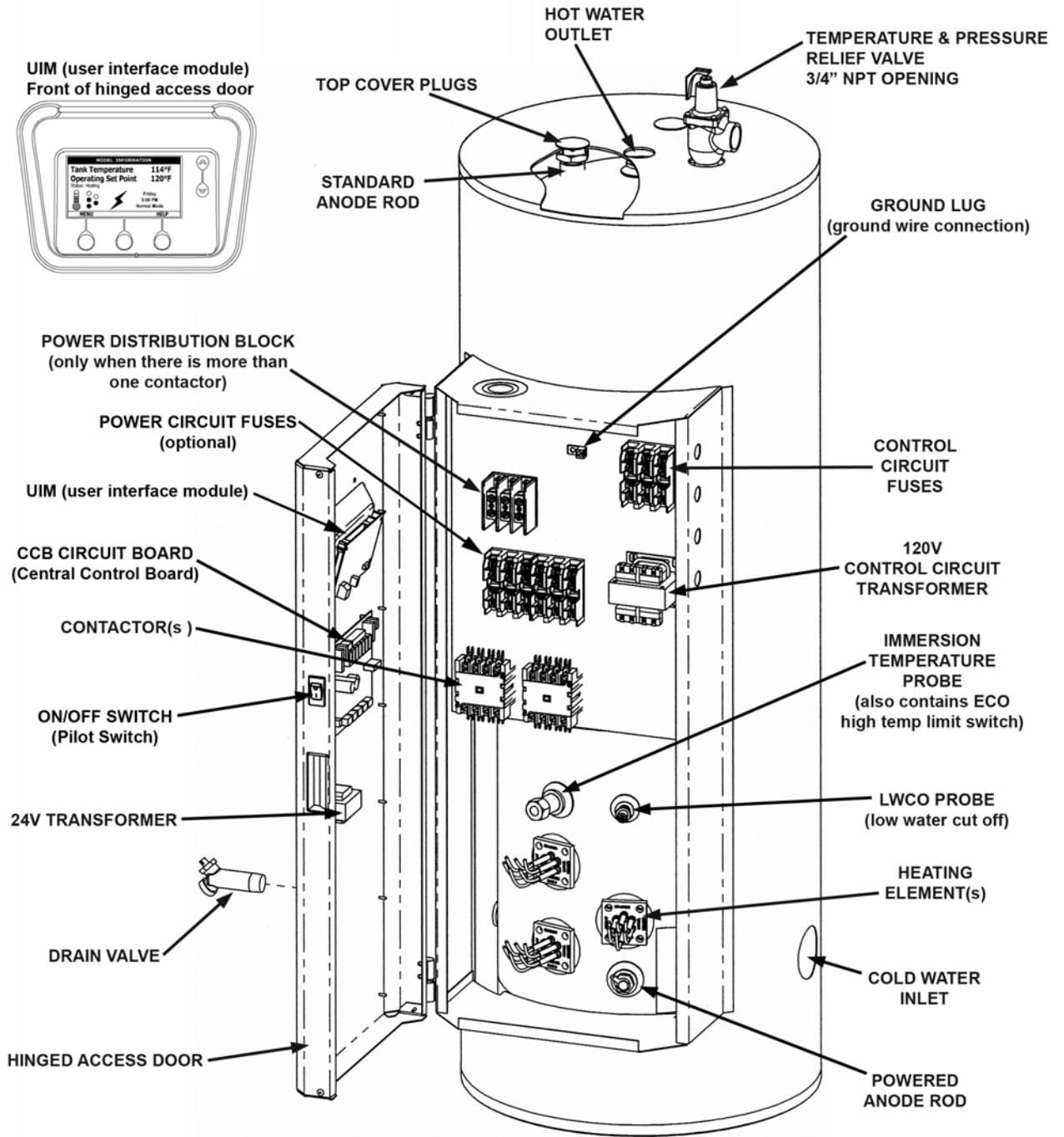

Figure 2

OPERATION & SERVICE

This section of the manual will cover principles of electricity, single and three phase power, fuses, heating element construction & operation, heating element sensors, contactors, common service procedures and more. Information and service procedures presented in this section will be referenced in the troubleshooting sections at the end of this manual.

PRINCIPLES OF ELECTRICITY

Voltage

The unit of measurement used to quantify electrical pressure or the force that causes electrical energy to flow is the volt or voltage. Volt meters are used to determine if there is an adequate supply of electricity or voltage to a heating element.

Amperage

The unit of measurement used to quantify the rate at which electrical current is flowing is the ampere or amp. Amp meters are used to determine if a heating element is working - if there is adequate current flowing through the heating element.

Ohms

The unit of measurement used to quantify the opposition or “resistance” to the flow of electricity is the ohm. As resistance (*ohms*) in an electrical circuit increases current (*amperage*) will decrease and as resistance decreases current will increase. Ohm meters are used for measuring the resistance of heating elements, for open circuit continuity tests on heating elements and for shorted to ground continuity tests on heating elements.

Service Note: Volt, ohm and amp meter test instruments are necessary to perform the service and diagnostic procedures outlined in this manual - see Tools Required on page 3.

Wattage

The unit of measurement used to quantify the rate or amount of electrical energy being used is the watt. One thousand watts is referred to as one kilowatt. Heating elements are rated in kilowatts expressed as KW. The higher the kilowatt rating of a heating element the more power it will use and the more heat it will generate. One kilowatt generates 3412 Btu of heat.

Ohms Law

A law that explains the relationship between voltage, current and resistance. The law states that the electric current flowing through a conductor is equal to the voltage divided by the resistance. The following equations further explain ohms law.

- V = Volts (electrical pressure)
- A = Amps (electrical flow/current)
- O = Ohms (resistance to electrical flow/current)
- W = Watts (rate or amount of electricity used)

Ohms Law applied to single phase power - each loop of a six wire element:

$V \div A = O$	$W \div V = A$	$V \div O = A$	$V \times A = W$	$A \times O = V$	$W \div A = V$
----------------	----------------	----------------	------------------	------------------	----------------

Ohms Law applied to three phase power - each wiring lead to a three wire element:

$0.577 \times W \div V = A$	$V \times A \times 1.73 = W$
-----------------------------	------------------------------

Service Note: See Heating Element Ratings on page 23 to determine the voltage and KW rating of a heating element.

SINGLE AND THREE PHASE POWER

These water heaters can be factory ordered for standard: 277/208/240/480 volt power. 277 volt models are single phase only - other voltages may be single or three phase.

Field Conversions

Some water heaters may be converted for single or three phase power within the guidelines listed below. Follow the phase conversion instructions provided in the Instruction manual that came with the water heater. Voltage/KW conversions ARE NOT permitted.

- 208/240 VAC models factory configured 24KW or less are convertible as single or three phase and include jumpers to make the conversion.
- 208/240 VAC models factory configured as single phase with over 24KW can be converted to three phase but jumpers are not provided.
- 208/240 VAC models factory configured as three phase with over 24KW cannot be converted to single phase.
- No 480 VAC models are phase convertible.
- Heating element voltage and KW conversions are not permitted on any models.

Verifying the power supply is correct is typical first step during most service procedures. The illustrations and instructions on the following pages will outline how this is done.

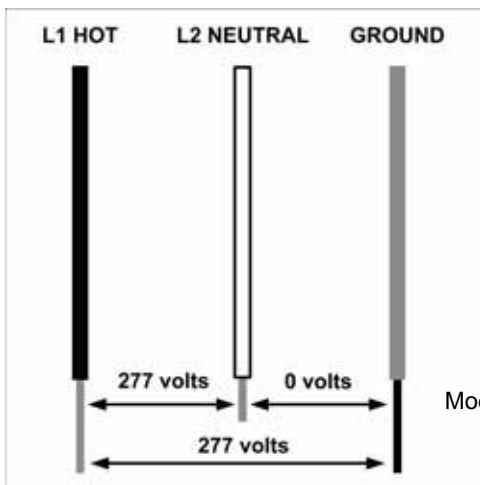

277 Volt 1Ø Power

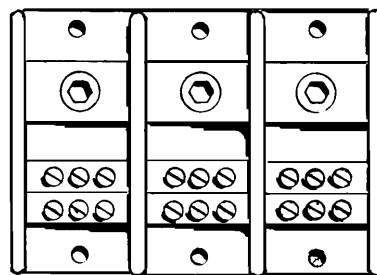

Power Distribution Block

Models with more than one heating element only.
See Figures 1 & 2 on pages 8 and 9.

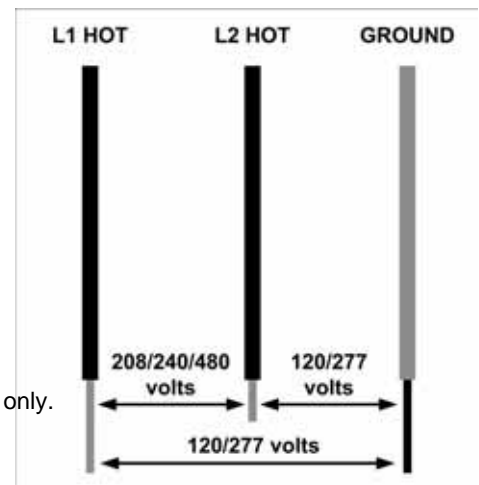

208/240/480 Volt 1Ø Power

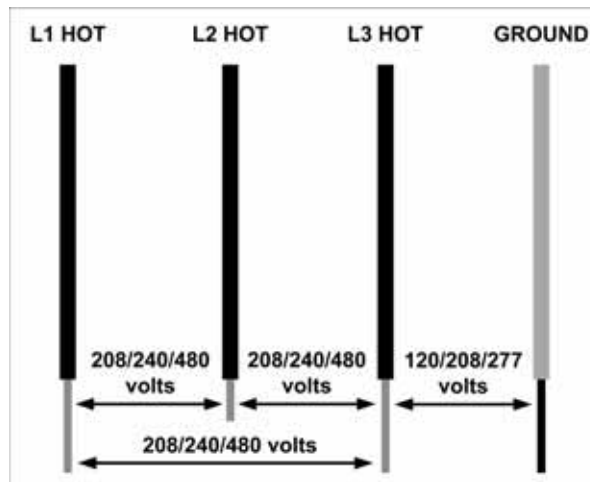

208/240/480 Volt 3Ø Power

Checking Single Phase (1Ø) Power

A single phase power supply will be connected to the L1 and L2 terminals of the Power Distribution Block or directly to the contactor on models equipped with a single element. On 208/240/480 volt power supplies both wires are “hot” with voltage present. On a 277 volt power supply one of the two wires is a “neutral” and does not have any voltage present. Check power supply voltage as follows:

- 1 With the power supply to the water heater turned on set the volt meter to an AC voltage range above the expected voltage (600 VAC or higher range initially).
- 2 Measure and record voltage between the [L1 & L2] terminals at the water heater’s Power Distribution Block or at the contactor on a single element model. Models equipped with a single element and a 4 pole contactor will require two voltage readings; one voltage reading between the first and second terminals of the contactor and a second voltage reading between the third and fourth terminals of the contactor.
- 3 Measure and record the voltage between the L1 terminal and the ground wire connection to the water heater. Check between L2 and ground in the same way. Note: models equipped with a single element and a 4 pole contactor will require four voltage readings; between the each of the 4 poles of the contactor and ground. On 208/240 volt power supplies each reading to ground should be approximately 120 volts. On 480 volt power supplies each reading to ground should be approximately 277 volts. On 277 volt power one of the wires is a neutral wire and will normally read approximately zero volts to ground.

Service Warning: Zero volt readings between terminals and ground can be due to an inadequate earth ground. **TREAT ALL WIRES AS BEING HOT** until it has been determined there is no voltage present.

If the voltage readings between terminals (step 2) or the voltage between any of the terminals and ground (step 3) was less than expected (< 95% expected): check the power supply to the water heater. Contact a Qualified/Licensed electrician to restore power. If the voltage readings taken in Step 2 above are a standard voltage (277/208/240/480) but do not match the listed voltage on the water heater’s rating label secure power to the water heater. **DO NOT** place the water heater back in service. Call the toll free Technical Support phone number listed on the back cover of this manual for further assistance.

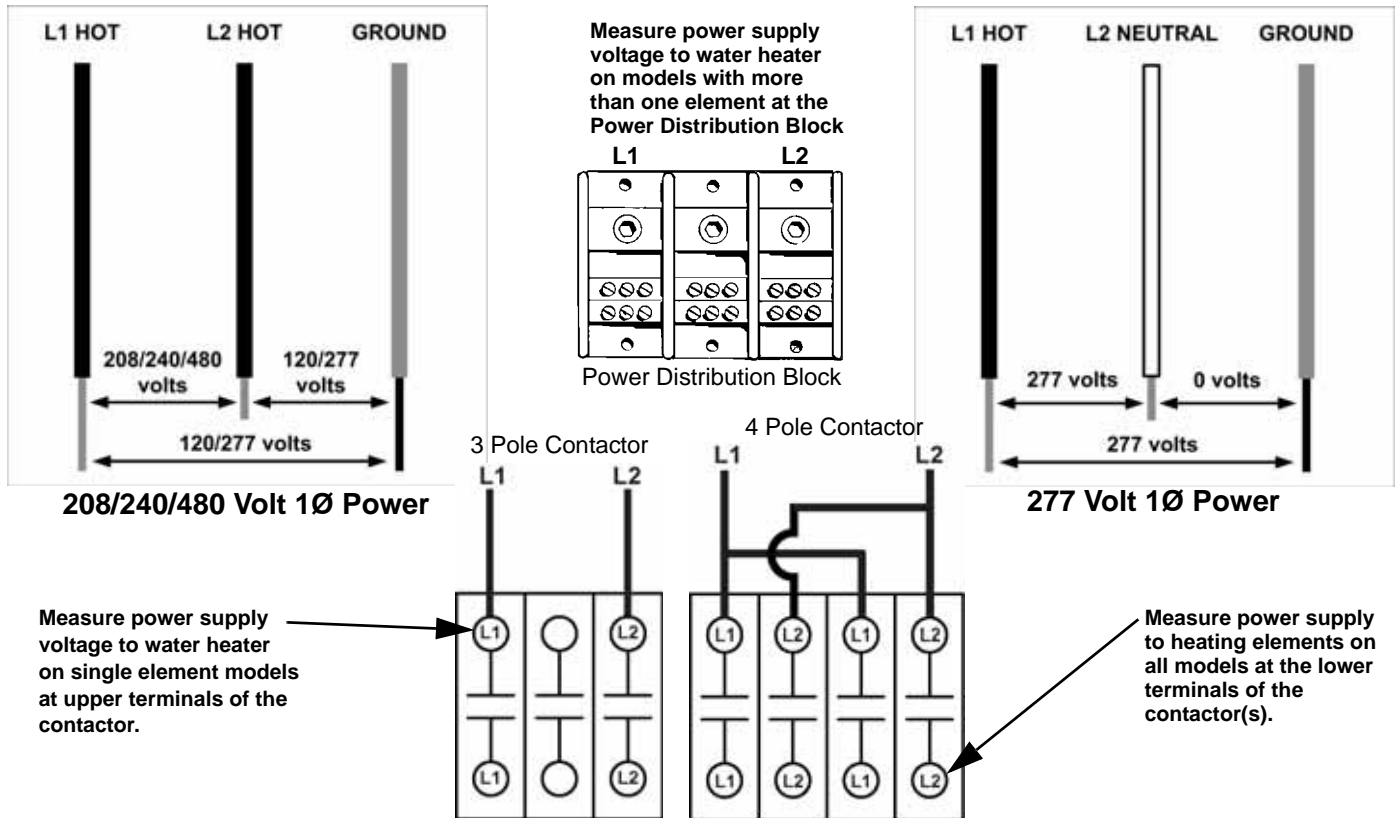

Checking Three Phase (3Ø) Power

A three phase power supply will be connected to the L1, L2 and L3 terminals of the Power Distribution Block or directly to the contactor on models equipped with a single element. All three wires are “hot” with voltage present. Check power supply voltage as follows:

- 1 With the power supply to the water heater turned on set the volt meter to an AC voltage range above the expected voltage (600 VAC or higher range initially).
- 2 Measure and record the voltage at the water heater’s Power Distribution Block or at the contactor on single element models. Measure voltage between; [L1 & L2], [L2 & L3] and [L1 & L3] terminals. This will be three voltage readings at a Power Distribution Block or a 3 pole contactor. Models equipped with a single heating element and a 4 pole contactor will require taking the voltage readings between the [L1 & L2] and [L2 & L3] terminals twice since there are two L2 terminals on the contactor - total of 4 voltage readings. All voltage readings should be approximately the same.
- 3 Measure and record the voltage between the L1 terminal and the ground wire connection to the water heater. Check between L2 and ground and L3 and ground in the same way. Note: models equipped with a single element and a 4 pole contactor will require four voltage readings; between the each of the 4 poles of the contactor and ground. On some 208 volt power supplies each reading to ground will be approximately 120 volts. Some 208 volt models will have a “stinger leg” with one of the three readings to ground measuring 208 volts - 208 volt stinger legs should be connected to L2. On 240 volt power supplies each reading to ground should be approximately 120 volts. On 480 volt power supplies each reading to ground should be approximately 277 volts.

Service Warning: Zero volt readings between terminals and ground can be due to an inadequate earth ground. **TREAT ALL WIRES AS BEING HOT** until it has been determined there is no voltage present.

If the voltage readings between terminals (step 2) or the voltage between any of the terminals and ground (step 3) was less than expected (< 95% expected): check power supply fuses, the breaker and/or disconnect switch supplying power to the water heater. Contact a Qualified/Licensed electrician to restore power. If the voltage readings taken in Step 2 above are a standard voltage (208/240/480) but do not match the listed voltage on the water heater’s rating label secure power to the water heater. **DO NOT** place the water heater back in service. Call the toll free Technical Support phone number listed on the back cover of this manual for further assistance.

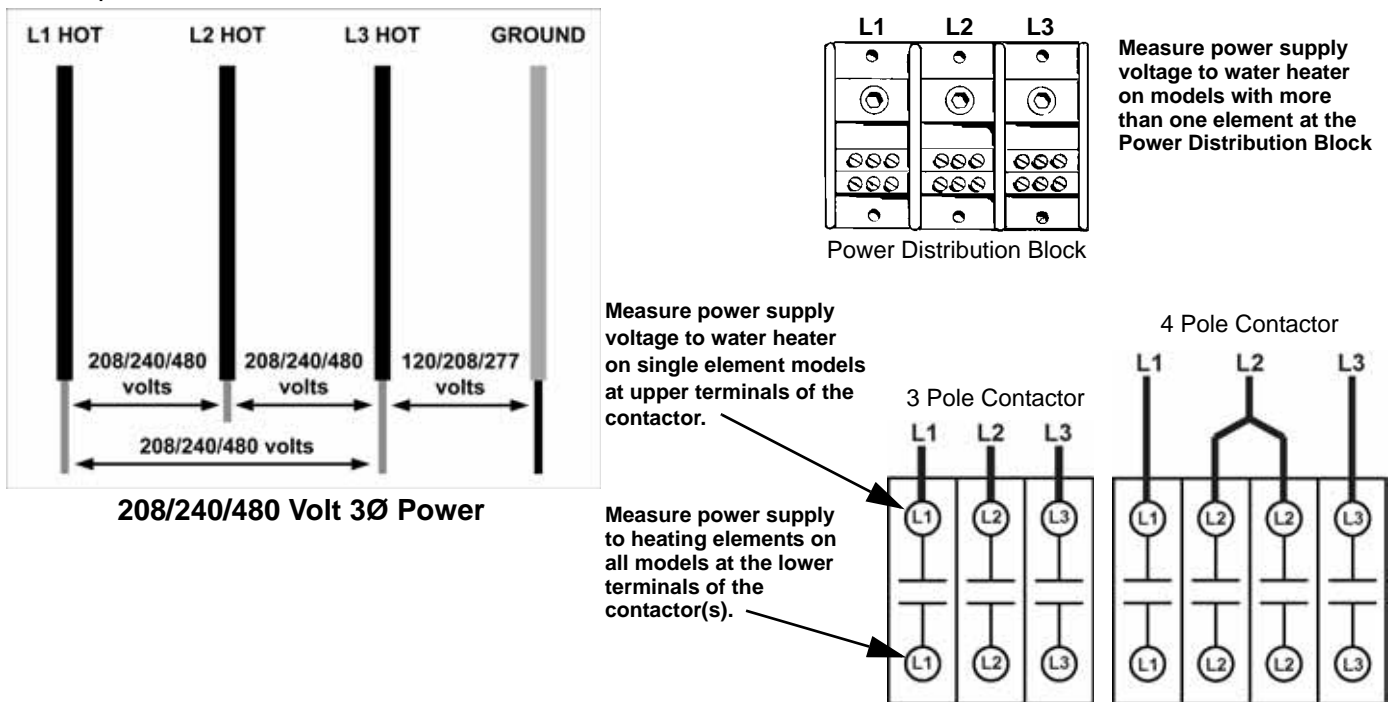

FUSES

Depending on total amp draw and how they were ordered some water heaters will be equipped with power circuit fuses to protect the heating element circuits. All models will have two fuses to protect the primary winding of the 120 Volt Control Circuit Transformer. See Figures 1 and 2 on pages 8 and 9 for location. Testing fuses requires an ohm meter, an AC volt meter and an insulated fuse puller - see Tools Required page 3.

Service Note - Replacement Fuses: Replacement fuses MUST BE of the same value and type as the factory installed fuses - call the toll free technical support or parts department phone number on the back cover of this manual for further assistance.

Ohm Meter Method

- 1 Secure power to the water heater at the main breaker or disconnect switch.
- 2 Remove each fuse to be tested with an insulated fuse puller.
- 3 Set the Ohm meter to it's lowest resistance range (< 200) or to an audible beep continuity test setting if so equipped.
- 4 Touch the meter probes to both ends of each fuse simultaneously.
- 5 If the fuse being tested shows a low resistance (< 1 ohms) or the continuity test feature sounds an audible beep the fuse being tested is good and can be re-installed.
- 6 If the fuse being tested shows infinite resistance (open circuit) or the continuity test feature does not sound an audible beep the fuse being tested is blown and must be replaced.

Ohm Meter Method

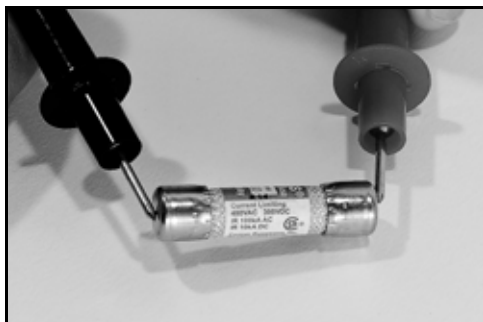

Volt Meter Method

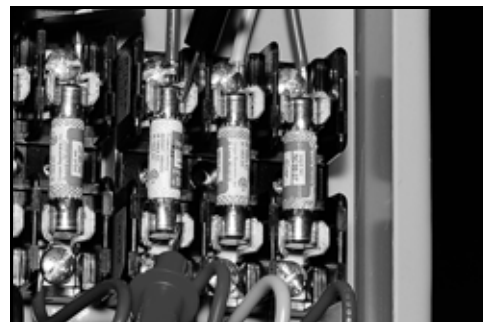

Volt Meter Method

Fuses can also be checked using an AC volt meter. The power supply must be turned on and a call for heat must be active (all contactors must be closed) during this test. Touch the two test probes to both ends of each fuse while still in the fuse blocks.

- A high voltage (at or above 120 VAC) reading indicates the fuse is blown.
- A zero volt reading generally indicates the fuse is good. Next check for voltage between each end of the fuse and ground to ensure voltage is present at both ends of the fuse. If no voltage is present between either end of the fuse and ground the test has not been conclusive - secure power to the water heater and perform the ohm meter test method described above.

The voltage test method is a good way to quickly identify fuses that are blown but it is not always conclusive due to the dependence on power being present at both ends of the fuse, all contactors being closed and correct wiring. Keep this in mind as there may be times when a fuse that is blown tests good due to one of these dependencies not being met. The ohm meter method described above may be more time consuming but it is 100% conclusive.

HEATING ELEMENTS

Heating Element Construction

The water heaters covered in this manual use electric heating elements to heat water. Heating elements convert electrical energy into heat energy.

Heating elements are constructed using 3 tubes formed into U shaped loops. The two ends of each loop are permanently fitted into the element flange. Inside each loop is a wire conductor (a resistive electrical circuit) surrounded by an insulating material. These wire conductors pose a relatively high resistance to the flow of electricity. Heat is generated when the electricity (*voltage*) applied to the element begins to flow (*amperage*) and encounters the resistance (*ohms*) of the wire conductors inside. See "Principles of Electricity" on page 10.

There are two types of heating elements installed in the water heaters covered in this manual; one type has six wire leads and the other has three wire leads. Heating elements with six wire leads are installed on water heaters configured for single phase and three phase power. Heating elements with three wire leads (Y configured) are installed on water heaters configured for three phase power only. See "Single And Three Phase Power" on page 12 and "Heating Element Wiring" section between pages 17 - 22.

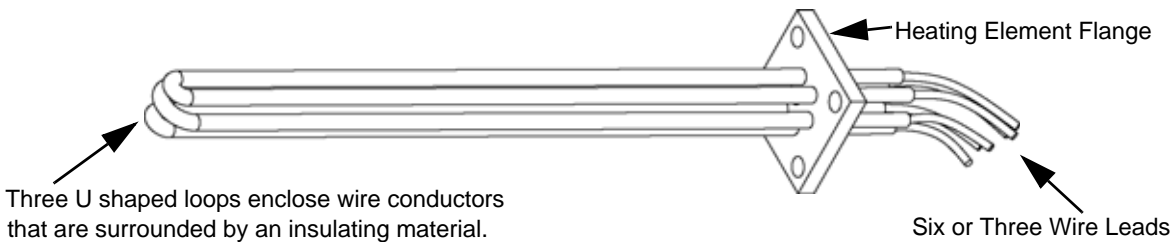

Heating Element Flange - End View

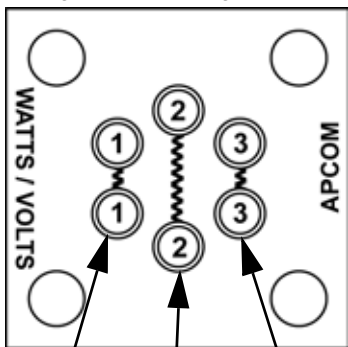

Two ends of loop 1 Two ends of loop 2 Two ends of loop 3

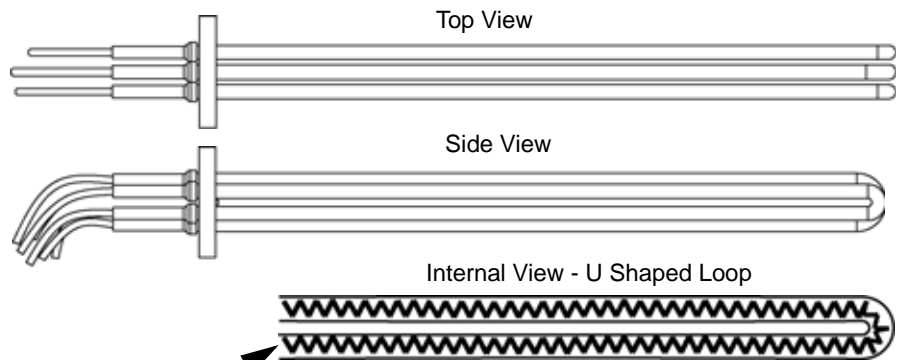

Resistive Circuits
Three resistive wire conductors inside three U shaped loops that are permanently fitted into a flange form the heating element.

Heating Element Wiring

This section will provide more detailed information on heating elements and how they are wired in single phase, three phase Delta and three phase Y configurations. See “Single And Three Phase Power” on page 12.

Six and Three Wire Heating Elements

Depending on how a water heater is ordered and factory configured it will be equipped with heating elements that have six wiring leads or three wiring leads. Six wire elements can be used with single or three phase power. Three wire (also called Y configured) heating elements are used with three phase power only.

Each heating element has 3 loops, each loop is a resistive circuit see “Heating Element Construction” on page 16. Six wire heating elements have a wire lead connected to both ends of the three loops. Three wire heating elements (Y configured) have a metal bar that joins or splices together one end from each of the three loops and a wire lead connected to the remaining end of each loop. See the illustrations below.

See also pages 18 - 22 for details on wiring between the heating elements and contactors.

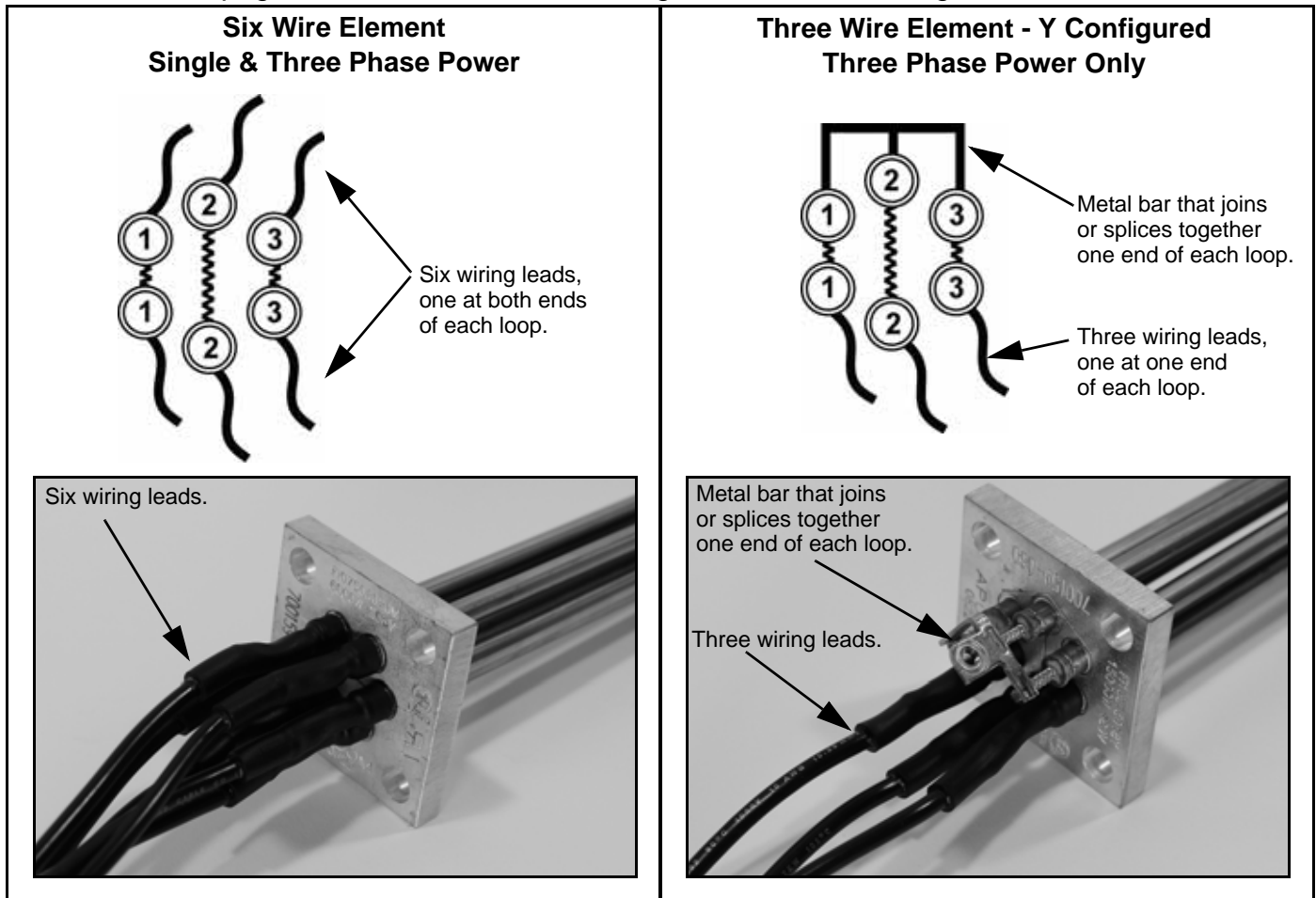

Single Phase Wiring - 3 Pole Contactor

The illustrations below show how six wire heating elements (page 17) are wired to 3 pole contactors on water heaters connected to a single phase power supply. See the "Contactors" section of this manual - pages 34 - 38.

Connection Diagram

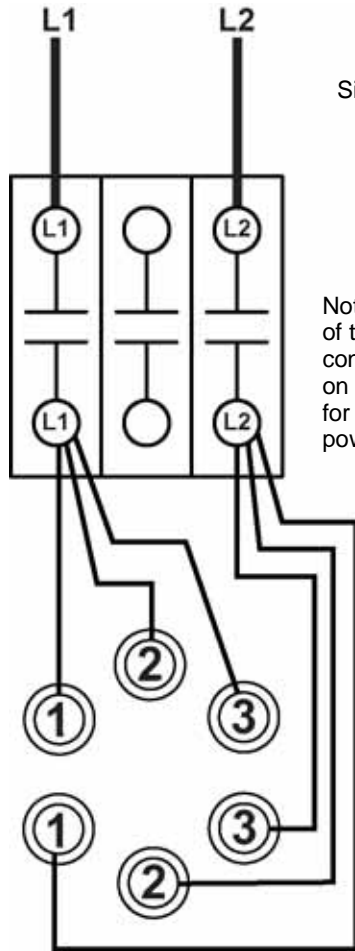

Wiring Diagram

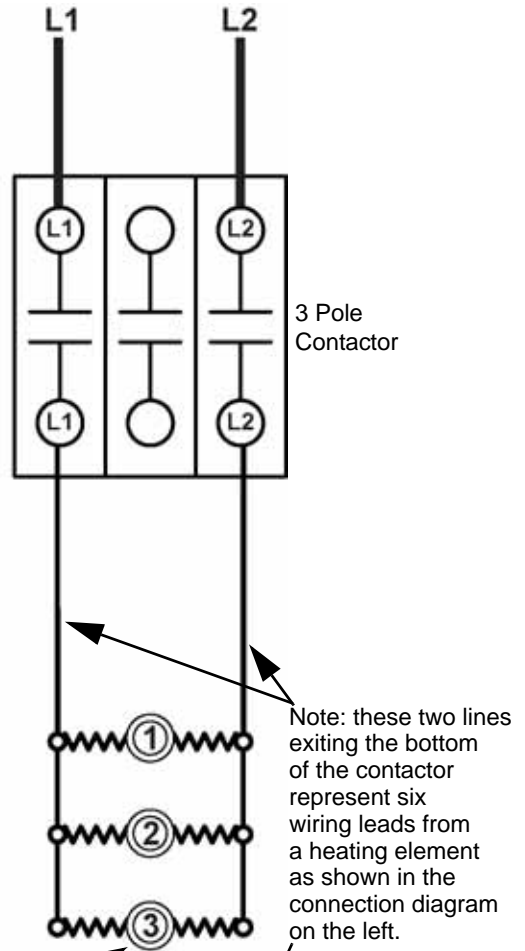

Heating Element Flange - End View

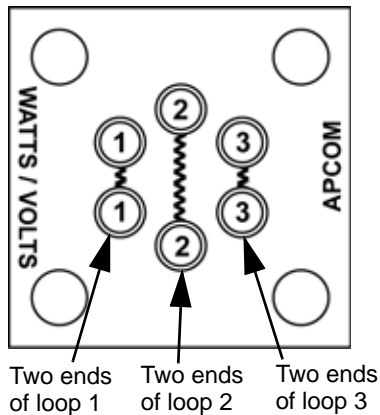

Three loops of one heating element

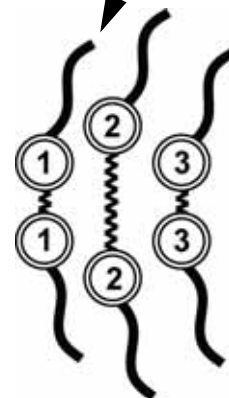

Single Phase Wiring - 4 Pole Contactor

The illustrations below show how six wire heating elements (page 17) are wired to 4 pole contactors on water heaters connected to a single phase power supply. See the "Contactors" section of this manual - pages 34 - 38.

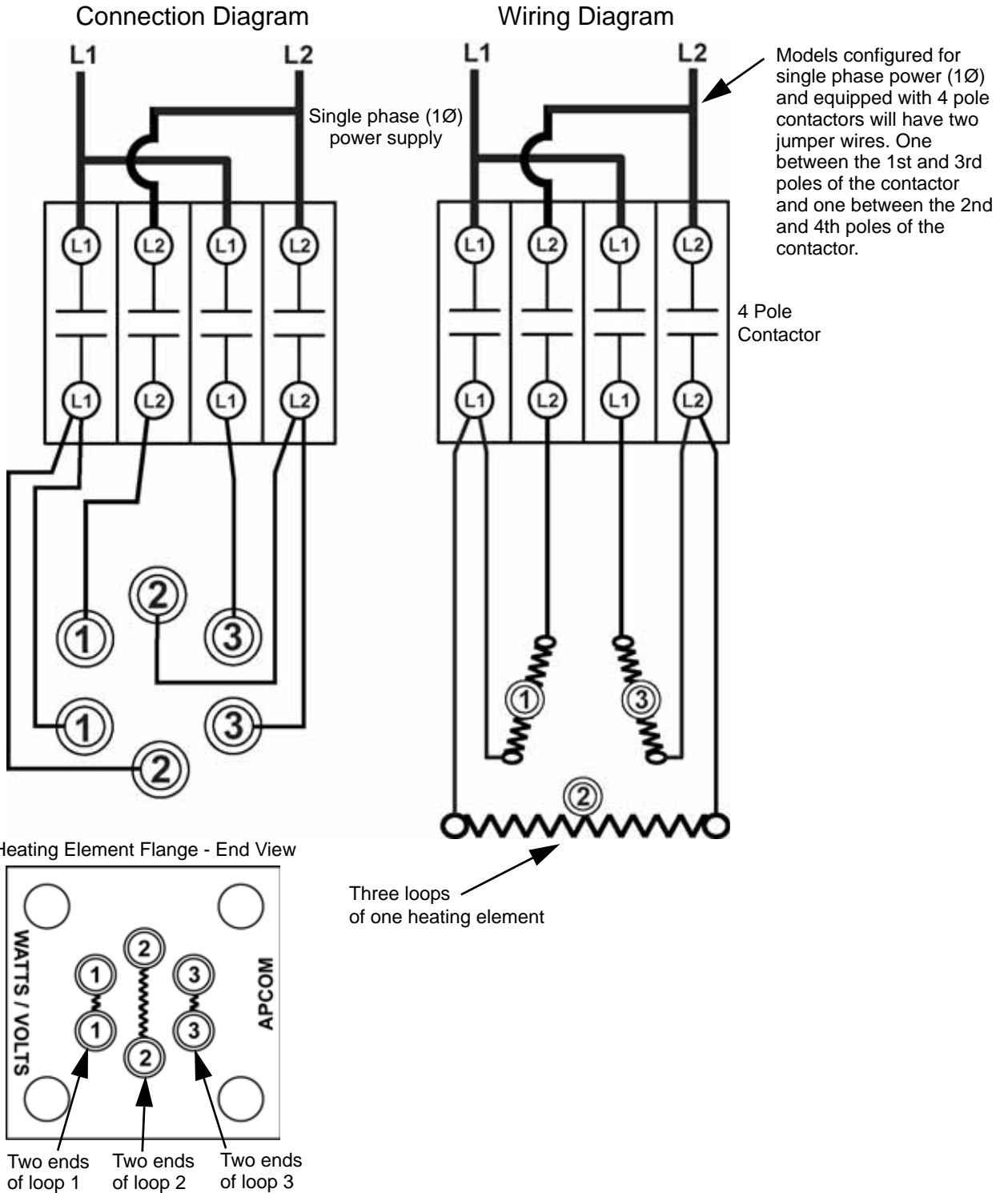

Three Phase Delta Wiring - 3 Pole Contactor

The illustrations below show how six wire heating elements (page 17) are wired to 3 pole contactors on water heaters connected to a three phase power supply. See the "Contactors" section of this manual - pages 34 - 38.

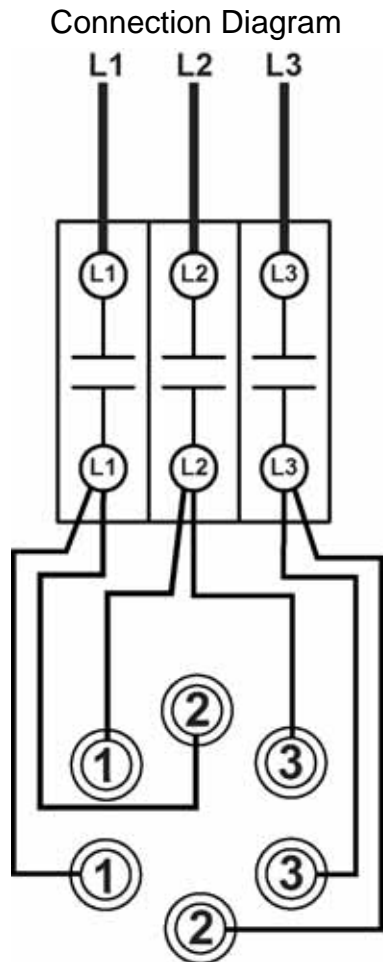

Three phase (3Ø)
power supply

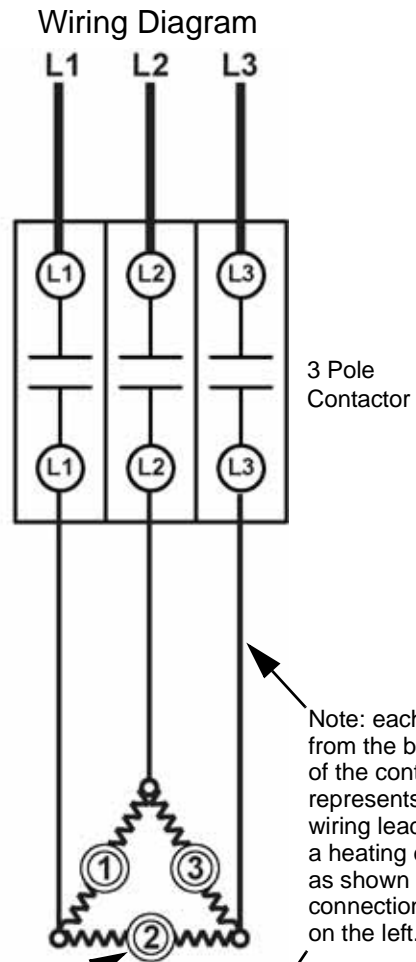

3 Pole
Contactor

Note: each line from the bottom of the contactor represents two wiring leads from a heating element as shown in the connection diagram on the left.

Three loops
of one heating element

Heating Element Flange - End View

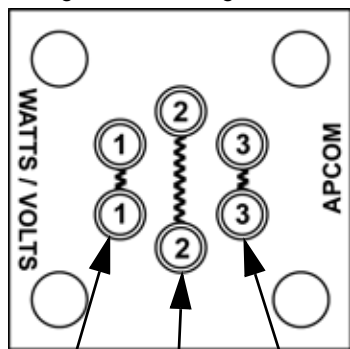

Two ends
of loop 1 Two ends
of loop 2 Two ends
of loop 3

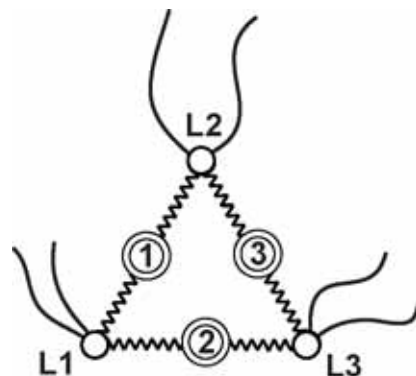

Three Phase Delta Wiring - 4 Pole Contactor

The illustrations below show how six wire heating elements (page 17) are wired to 4 pole contactors on water heaters connected to a three phase power supply. See the "Contactors" section of this manual - pages 34 - 38.

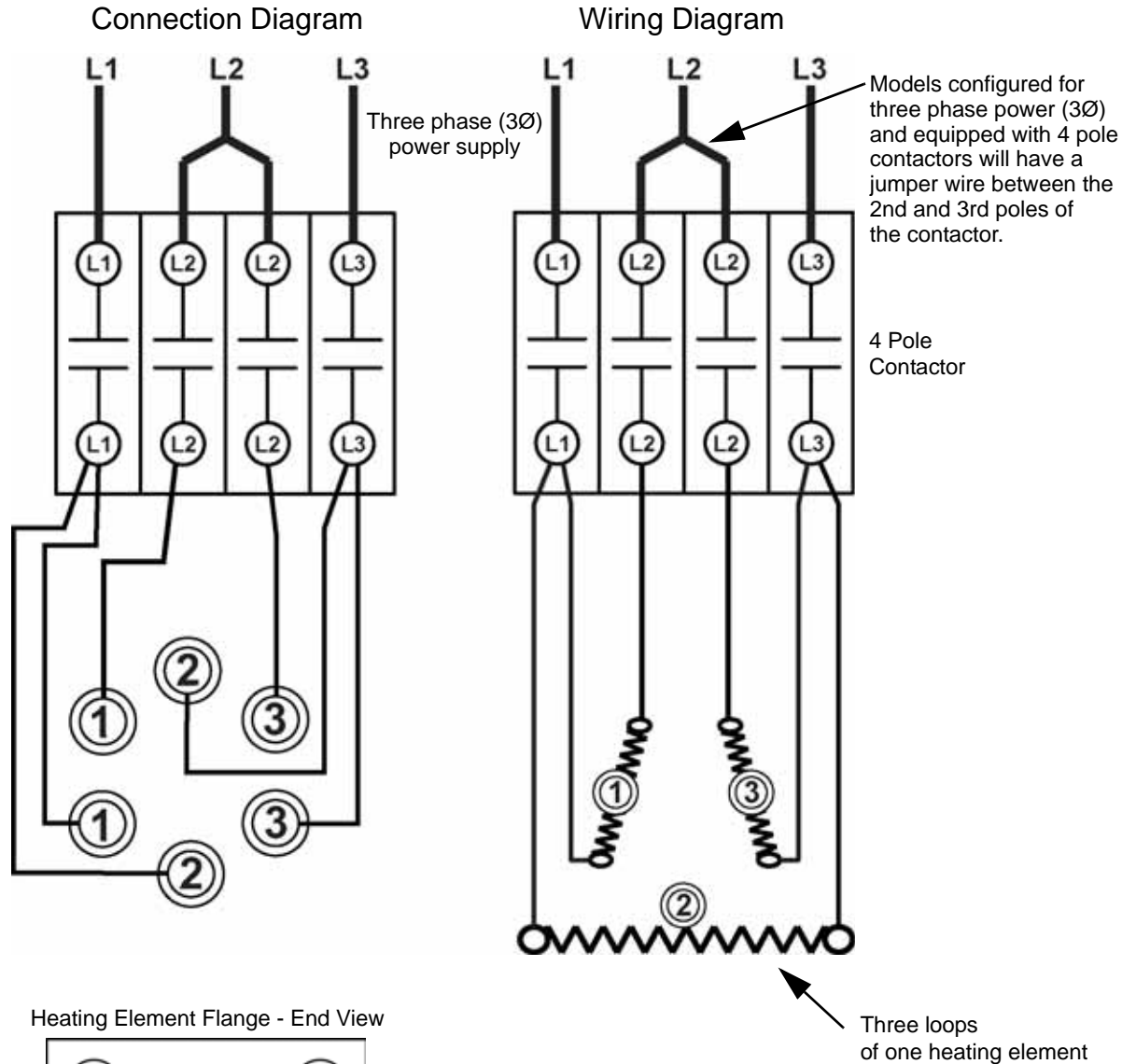

Heating Element Flange - End View

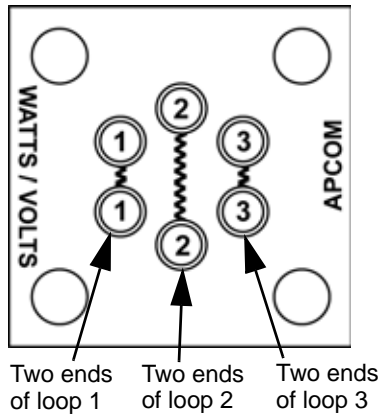

Three Phase Y Configuration - 3 Pole Contactor

The illustrations below show how three wire (Y configured) heating elements (page 17) are wired to 3 pole contactors on water heaters connected to a three phase power supply. See the "Contactors" section of this manual - pages 34 - 38.

Connection Diagram

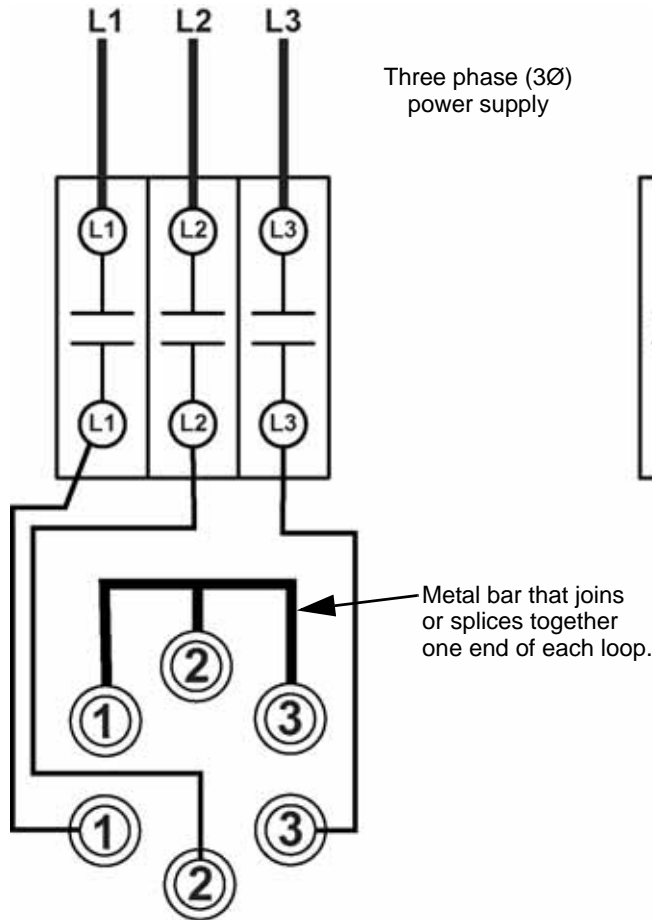

Wiring Diagram

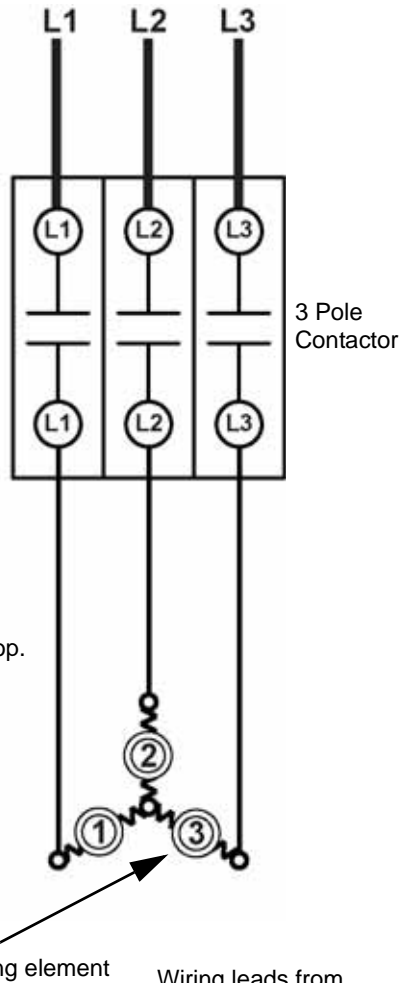

Heating Element Flange - End View

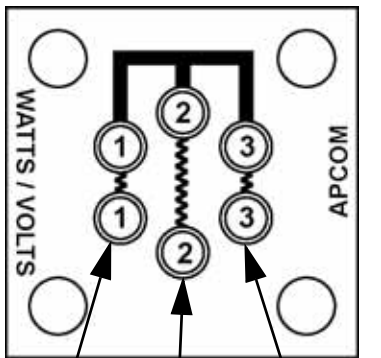

Two ends of loop 1 Two ends of loop 2 Two ends of loop 3

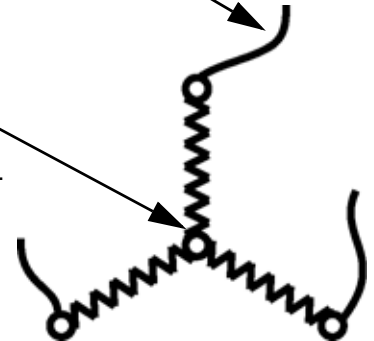
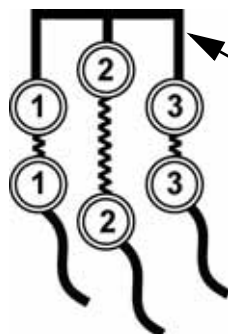

Heating Element Ratings

There are six “standard” heating element KW ratings used; 3, 6, 9, 12, 15 and 18KW. Heating element flanges are stamped with the part number, voltage and KW rating - see the illustration to the right.

Heating Element Flange

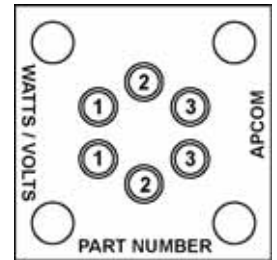

Heating Element Configurations

The table below shows standard heating element configurations used. Keep in mind the water heaters covered by this service manual can be custom ordered with heating element voltage and KW ratings other than what is shown in this table. Always check the water heater’s rating label to see how the water heater was configured at the factory.

Service Note: Models at 54 KW and above are not available in 208 single phase (1Ø) configurations. Also notice that some 208 volt models will contain additional elements.

STANDARD KW INPUT RATINGS	NUMBER OF ELEMENTS AND WATTAGE
3	1 - 3,000
6	1 - 6,000
9	1 - 9,000
12	1 - 12,000
15	1 - 15,000
18	1 - 18,000
*18	2 - 9,000
24	2 - 12,000
30	2 - 15,000
36	2 - 18,000
*36	3 - 12,000
45	3 - 15,000
54	3 - 18,000
**60	4 - 15,000
**75	5 - 15,000
**90	5 - 18,000

* 208 Volt models use one additional element.

** Only Available in 50 gallon models or larger.

Heating Element Amperage - Six Wire Elements

The table below shows the approximate amp draw through each loop (see page 17) of a six wire heating element. First determine the actual rated wattage and voltage of the element being tested - see page 23. Then follow the Heating Element Amperage Test procedure on page 25 to measure amperage through each loop of the six wire heating element being tested. The 3 amp readings, one for each loop, should be approximately the same. Compare the measured values to the values in the table below. Keep in mind there may be some variance between measured values and the values in this table due to fluctuations in voltage, temperature and the calibration of test instruments being used.

SIX WIRE ELEMENT TABLE

TOTAL ELEMENT WATTAGE	WATTAGE PER LOOP	APPROXIMATE AMPS THROUGH EACH LOOP			
		208 VAC	240 VAC	277 VAC	480 VAC
3,000	1,000	4.81	4.17	3.61	2.08
6,000	2,000	9.62	8.33	7.22	4.17
9,000	3,000	14.42	12.50	10.83	6.25
12,000	4,000	19.23	16.67	14.44	8.33
15,000	5,000	24.04	20.83	18.05	10.42
18,000	6,000	28.85	25.00	21.66	12.50

Heating Element Amperage - Three Wire (Y Configured) Elements

The table below shows the approximate amp draw through each wire (see page 17) of a three wire heating element. First determine the actual rated wattage and voltage of the element being tested - see page 23. Then follow the Heating Element Amperage test procedure on page 25 to measure amperage through each wire of the three wire heating element being tested. The 3 amp readings should be approximately the same. Compare the measured values to the values in the table below. Keep in mind there may be some variance between measured values and the values in this table due to fluctuations in voltage, temperature and the calibration of test instruments being used.

3 WIRE (Y CONFIGURED) ELEMENT TABLE

TOTAL ELEMENT WATTAGE	APPROXIMATE AMPS THROUGH EACH WIRE		
	208 VAC	240 VAC	480 VAC
3,000	8.32	7.21	3.61
6,000	16.64	14.43	7.21
9,000	24.97	21.64	10.82
12,000	33.29	28.85	14.43
15,000	41.61	36.06	18.03
18,000	49.93	43.28	21.64

Heating Element Amperage Test

This test should be considered as a first diagnostic procedure for the common service complaints of no hot water or not enough hot water. The heating element amperage test shown on this page is the best procedure to quickly determine which (if any) heating elements are not working properly.

- 1 Ensure tank temperature is less than 100°F/38°C - dump water to lower tank temperature if necessary.
- 2 Adjust the temperature settings to ensure a call for heat is active for all heating elements. Raise the Operating Set Point to 140°F or higher. Set all Differentials at 2°F - see pages 61 and 62.
- 3 Using a clamp style AC amp meter: set the amp meter to an AC amperage range just above the expected amperage (100 AC amp range initially). The normal operating amps for all standard heating elements/ loops is provided in the tables on page 24 or it can be calculated using ohms law as explained on page 11. Follow the procedure below that corresponds to the type, six or three wire element, of heating element being tested - see explanation on pages 16 & 17. When measuring amperage clamp the jaws of the amp meter around ONLY ONE WIRE at a time.

Six Wire Elements: Measure and record amperage by clamping the jaws of the amp meter around one wire from each of the three element loops on the heating element being tested - three amp readings. Ensure you are not measuring the amp draw of the same loop more than once. See the connection/wiring diagram on pages 18 - 21 that corresponds to the power supply phase and type of contactor(s) installed on the water heater being serviced. The three amp readings should be approximately the same.

Three Wire Elements: Measure and record amperage by clamping the jaws of the amp meter around each of the three heating element wires - three amp readings. See the connection/wiring diagrams on page 22. The three amp readings should be approximately the same.

Service Notes: If the measured amps on any heating element loop/wire is zero amps perform the Heating Element Voltage test (page 26) and the Heating Element Resistance & Ground tests (pages 29 - 30).

If the measured amps on any heating element loop/wire is considerably less or more ($\pm 20\%$) than the normal operating amps shown in the tables on page 24 ensure the voltage and KW rating of those heating elements are the correct ratings for the water heater being serviced - see the rating label on the water heater and Heating Element Ratings on page 23. If the heating element voltage and KW ratings are correct perform the Heating Element Resistance & Ground tests on pages 29 - 30. If the element voltage and KW ratings do not match the rating label call the toll free Technical Support phone number listed on the back cover of this manual for further assistance.

Three Wire Element Being Tested

Measuring amperage on an electric heating element. Make sure the jaws of the AC amp meter are clamped around ONLY ONE WIRE from each heating element at a time. Take 3 amp readings; one for each heating element loop/wire. The three readings should be approximately the same.



Heating Element Voltage Test

This test is typically performed after an amperage test (page 25) has determined one or more heating elements (or heating element loops) is not drawing the correct amperage.

There are five standard element/contacter wiring configurations for the water heaters covered by this manual - see pages 18 - 22. This is due to differences in power supply phase, type of contactor(s) installed and the type of heating elements installed. Because of these differences there will be five different methods to measure voltage to the heating elements.

Voltage to the heating elements is always measured at the lower (output) terminals/poles of each contactor. The measured voltage should always match the listed voltage on the water heater's rating label.

Single Phase (1Ø) Power

Three Phase (3Ø) Power

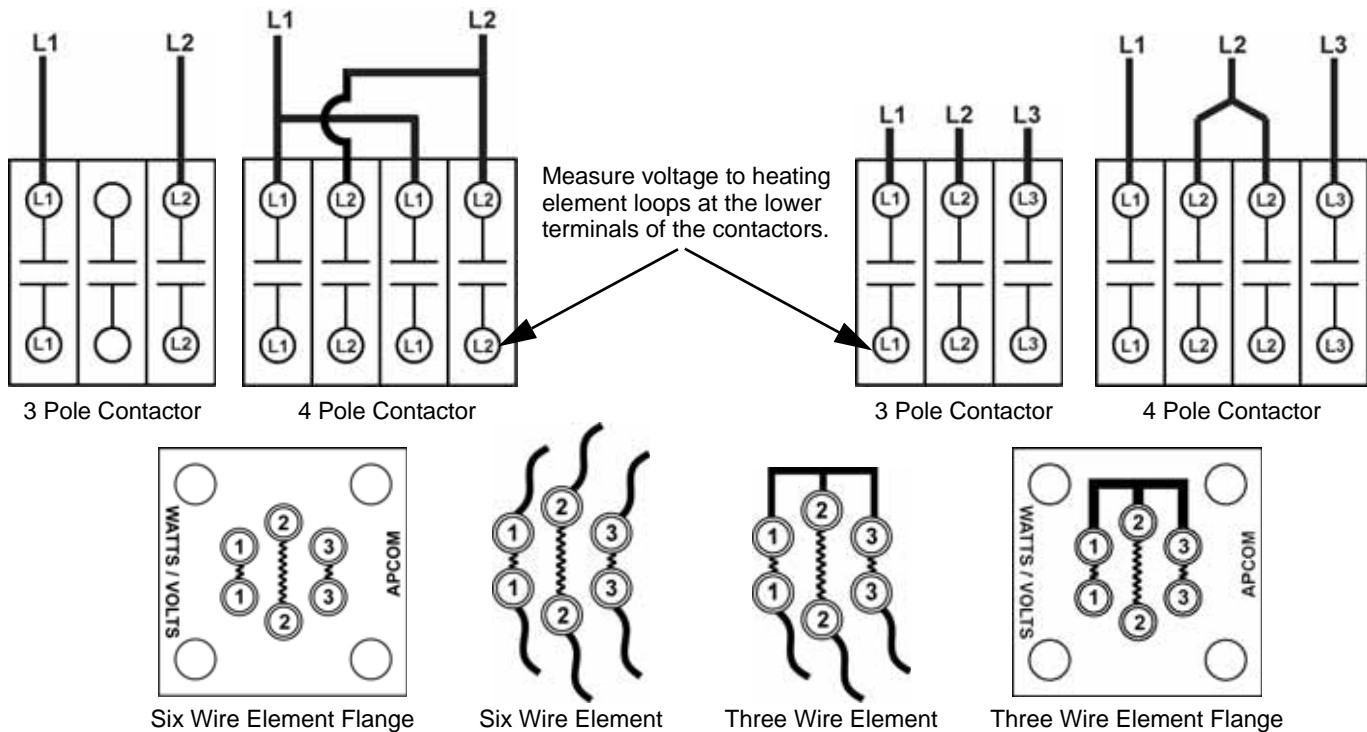

Voltage Test Procedure

- 1 Determine power supply phase/voltage to the water heater - see the water heater's rating label.
- 2 Determine if the water heater is equipped with a 3 pole or 4 pole contactor(s) - see page 35.
- 3 Determine if the water heater is equipped with six or three wire heating elements - see page 17.
- 4 Locate the heating element connection/wiring diagram that corresponds to the power supply phase, type of contactor and type of element(s) determined in Steps 1 - 3 above. See pages 18 - 22.
- 5 Ensure tank temperature is less than 100°F/38°C - dump water to lower tank temperature if necessary.
- 6 Adjust the temperature settings to ensure a call for heat is active for all heating elements. Raise the Operating Set Point to 140°F or higher. Set all Differentials at 2°F - see pages 61 and 62.
- 7 Set the AC volt meter to a range above the expected voltage (600 VAC or higher range initially).
- 8 Follow the instruction from the list on page 27 that corresponds with the power supply phase, type of contactor(s) and type of heating element(s) on the water heater being serviced as determined in Steps 1 - 3 above.

Heating Element Voltage Test (cont)

A Single Phase Power - 3 Pole Contactor - Six Wire Element (see diagrams page 18):

- 1 Measure and record voltage to all three heating element loops between the first and third lower terminals of the contactor - L1 & L2.

Note: All three element loops are wired to the first and third lower terminals on the contactor. Repeat this procedure at each contactor(s) for other heating elements being tested.

B Single Phase Power - 4 Pole Contactor - Six Wire Element (see diagrams page 19):

- 1 Measure and record voltage to the #1 heating element loop between the first and second lower terminals of the contactor - L1 & L2.
- 2 Measure and record voltage to the #2 heating element loop between the first and fourth lower terminals of the contactor - L1 & L2.
- 3 Measure and record voltage to the #3 heating element loop between the third and fourth lower terminals of the contactor - L1 & L2.

Note: All three voltage readings should be approximately the same. Repeat this procedure at each contactor(s) for other heating elements being tested.

D Three Phase Power - 3 Pole Contactor - Six Wire Element (see diagrams page 20):

- 1 Measure and record voltage to the #1 heating element loop between the first and second lower terminals of the contactor - L1 & L2.
- 2 Measure and record voltage to the #2 heating element loop between the first and third lower terminals of the contactor - L1 & L3.
- 3 Measure and record voltage to the #3 heating element loop between the second and third lower terminals of the contactor - L2 & L3.

Note: All three voltage readings should be approximately the same. Repeat this procedure at each contactor(s) for other heating elements being tested.

D Three Phase Power - 4 Pole Contactor - Six Wire Element (see diagrams page 21):

- 1 Measure and record voltage to the #1 heating element loop between the first and second lower terminals of the contactor - L1 & L2.
- 2 Measure and record voltage to the #2 heating element loop between the first and fourth lower terminals of the contactor - L1 & L3.
- 3 Measure and record voltage to the #3 heating element loop between the third and fourth lower terminals of the contactor - L2 & L3.

Note: All three voltage readings should be approximately the same. Repeat this procedure at each contactor(s) for other heating elements being tested.

D Three Phase Power - 3 Pole Contactor - Three Wire Element (see diagrams page 22):

- 1 Measure and record voltage between the first & second lower terminals of the contactor - L1 & L2.
- 2 Measure and record voltage between the first & third lower terminals of the contactor - L1 & L3.
- 3 Measure and record voltage between the second & third lower terminals of the contactor - L2 & L3.

Note: All three voltage readings should be approximately the same. Repeat this procedure at each contactor(s) for other heating elements being tested.

Service Notes: If the voltage is low or not present in any of the tests above - check power to the water heater (pages 12 - 14). Check fuses (page 15). Ensure heating element power circuit wiring is correct (see wiring diagram on water heater) ensure all wiring and connections are tight and making good contact. Check contactors (see pages 34 - 38). If the measured voltage is a standard voltage (277/208/240/480) but does not match the listed voltage on the water heater's rating label secure power to the water heater. DO NOT place the water heater back in service. Call the toll free Technical Support phone number listed on the back cover of this manual for further assistance.

Heating Element Resistance - Six Wire Elements

This table shows the approximate resistance (in ohms) of each loop (see page 17) in a six wire heating element. First determine the actual rated wattage and voltage of the element being tested - see page 23. Then follow the Measuring Resistance test procedure on page 29 to measure the resistance of each loop of the six wire element being tested. The 3 ohm readings, one for each loop, should be approximately the same. Compare the measured resistance to the values in the table below. Keep in mind there will be some variance between measured values and the values in this table due to fluctuations in temperature and the calibration of test instruments being used.

SIX WIRE ELEMENT TABLE

TOTAL ELEMENT WATTAGE	WATTAGE PER LOOP	APPROXIMATE OHMS OF EACH LOOP			
		208 VAC	240 VAC	277 VAC	480 VAC
3,000	1,000	43.26	57.60	76.73	230.40
6,000	2,000	21.63	28.80	38.36	115.20
9,000	3,000	14.42	19.20	25.58	76.80
12,000	4,000	10.82	14.40	19.18	57.60
15,000	5,000	8.65	11.52	15.35	46.08
18,000	6,000	7.21	9.60	12.79	38.40

Heating Element Resistance - Three Wire (Y Configured) Elements

This table shows the approximate resistance (in ohms) between each wiring lead and the metal shorting bar on the element flange (see page 17) in a three wire heating element. First determine the actual rated wattage and voltage of the element being tested - see page 23. Then follow the Measuring Resistance test procedure on page 29 to measure the resistance between each wiring lead and shorting bar on the element being tested. The 3 ohm readings should be approximately the same. Compare the measured resistance to the values in the table below. Keep in mind there will be some variance between measured values and the values in this table due to fluctuations in temperature and the calibration of test instruments being used.

3 WIRE (Y CONFIGURED) ELEMENT TABLE

TOTAL ELEMENT WATTAGE	APPROXIMATE OHMS BETWEEN EACH WIRE END AND THE METAL SHORTING BAR		
	208 VAC	240 VAC	480 VAC
3,000	14.43	19.21	76.85
6,000	7.22	9.61	38.42
9,000	4.81	6.40	25.62
12,000	3.61	4.80	19.21
15,000	2.89	3.84	15.37
18,000	2.41	3.20	12.81

Heating Element Resistance & Ground Tests

This is a two part test. In the first test the actual resistance (ohms) of each heating element loop is measured. In the second part of this test each heating element loop is tested for any continuity to ground to ensure the heating element is not shorted to ground. These tests should be considered as third and fourth diagnostic procedures to be performed whenever the results from the Heating Element Amperage Test showed a heating element was not drawing the correct amps AND the results from the Heating Element Voltage Test showed the element had the proper voltage applied.

Measuring Resistance

- 1 Determine what the actual voltage and KW rating is for the heating elements in the water heater being serviced - see Heating Element Ratings on page 23. Ensure the voltage and KW rating of those heating elements are the correct ratings for the water heater being serviced - see the rating label on the water heater. Replace any elements that are not the proper rating for the water heater being serviced before proceeding.
- 2 Secure power to the water heater at the main breaker or disconnect switch.
- 3 Verify with an AC volt meter that there is not any voltage present at the Power Distribution Block (see Figure 2 on page 9) or the contactor on single element models.
- 4 Disconnect and label the power wires from the contactor(s) to all elements being tested. Pay close attention to wiring and which heating element loops (see pages 16 & 17) connect to which terminals on the contactor(s). Use wire markers (see Tools Required page 3) to label contactor terminals and/or the wiring leads of the heating element to ensure they are reconnected properly when finished.
- 5 Using an ohm meter: set the ohm meter to a range just above the expected ohms (200 ohm range initially).

Six Wire Elements: Measure and record the resistance (ohms) between the two wire ends from each loop on the heating element - three ohm readings. Note the pattern the three loops form on the heating element flange on a six wire element as shown in the illustrations on pages 16 and 17. Ensure you are not measuring the resistance of the same loop more than once. Ensure you are not measuring resistance between wires from two separate loops. The three ohm readings should be approximately the same.

Three Wire Elements: Measure and record the resistance (ohms) between each wire end of the heating element and the metal bar that shorts/splices together one end of each heating element loop on a three wire element - three ohm readings. See the illustrations on pages 16 and 17. The three ohm readings should be approximately the same.

Compare the measured ohms values to the values given in the Heating Element Resistance tables on page 28 for the correct type (six or three wire) element being tested.

If the resistance reading for any element/loop is infinite (no continuity) - the heating element is defective and must be replaced - see page 31.

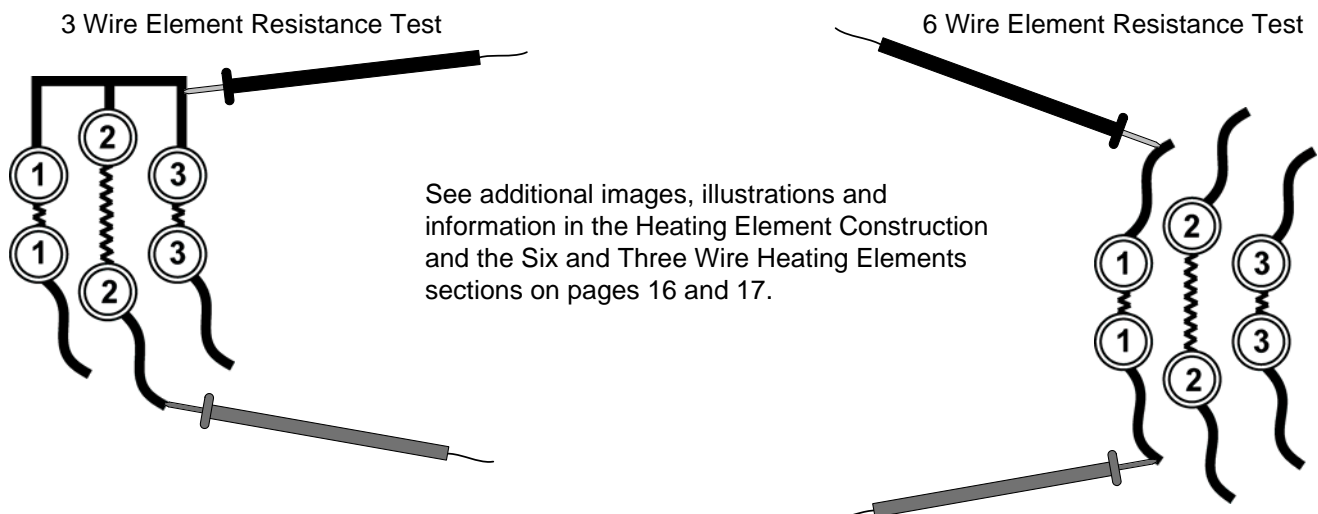

Heating Element Ground Test

- 1 Secure power to the water heater at the main breaker or disconnect switch.
- 2 Verify with an AC volt meter that there is not any voltage present at the Power Distribution Block (see Figure 2 on page 9) or the contactor on single element models.
- 3 Disconnect and label the power wires from the contactor(s) to all elements being tested. Pay close attention to wiring and which heating element loops (see pages 16 & 17) connect to which terminals on the contactor(s). Use wire markers (see Tools Required page 3) to label contactor terminals and/or the wiring leads of the heating element to ensure they are reconnected properly when finished.
- 4 Using an ohm meter: set the ohm meter to one of it's lowest resistance ranges - 200 ohms or less initially. An audible beep continuity test setting can also be used on ohm meters so equipped.

Six Wire Elements: Test for continuity (ohms/resistance) between all six wire ends from each loop on the heating element and the ground wire connection to the water heater - six continuity readings. See pages 16 & 17 and the illustrations below. There should not be any continuity between any wire and ground.

Three Wire Elements: Test for continuity (ohms/resistance) between all three wire ends of the heating element and the ground wire connection to the water heater - three continuity readings. See pages 16 & 17 and the illustrations below. There should not be any continuity between any wire and ground.

The resistance in these tests should be infinite - no continuity to ground. If there is any resistance or continuity measured between any element wire end and ground - the heating element is shorted to ground and must be replaced - see page 31.

Checking a heating element for any resistance or continuity to ground. Touch one of the ohm meter probes to one wiring lead from a heating element and the other probe to a grounded surface on the water heater. Take additional continuity to ground readings for all wiring leads on a heating element.

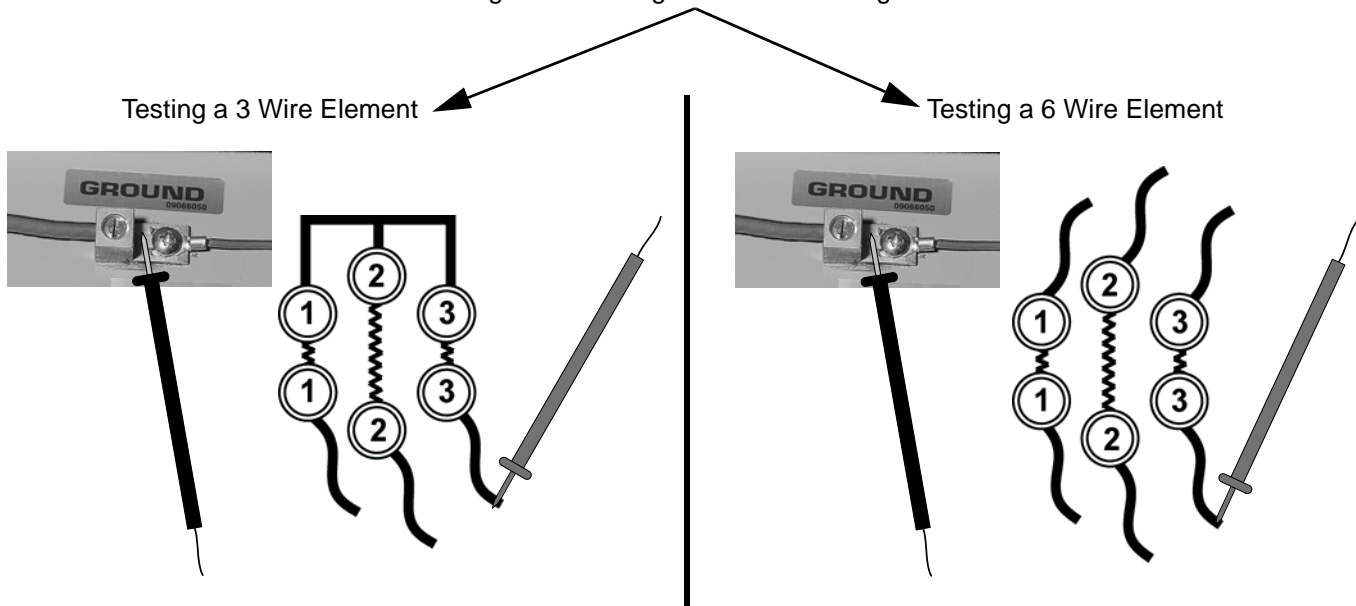

Replacing Heating Elements

- 1 Secure power to the water heater at the main breaker or disconnect switch.
- 2 Verify with an AC volt meter that there is not any voltage present at the Power Distribution Block and contactors inside the water heater - see Figures 1 and 2 on pages 8 and 9 for location and pages 12 - 14 for power supply test procedures.
- 3 Close the cold water supply valve to the water heater and drain the water heater - follow the draining instructions in the Maintenance Section of Instruction Manual that came with the water heater. If the Instruction Manual is not available copies can be obtained from the manufacturers web site or by calling the toll free phone number on the back cover of this manual.
- 4 Remove the four heating element flange bolts and remove the heating element(s) being replaced - leave wiring leads connected to the contactor(s).
- 5 Disconnect all wiring leads from the old heating element at the contactor(s). Pay close attention to wiring leads and which heating element loops (see pages 16 & 17) connect to which terminals on the contactor(s). Use wire markers (see Tools Required page 3) to label contactor terminals and/or the wiring leads of the heating element to ensure the new element is properly wired.
- 6 Install the new heating element and a new element gasket. Install/tighten four heating element flange bolts. Replacement elements and gaskets can be obtained from local distributors or by calling the toll free phone number on the back cover of this manual.
- 7 Connect the new heating element wiring leads to the contactor(s) according to the wiring diagram on the water heater and the wire marker labels attached in Step 5 above. Securely tighten wiring leads at contactor(s).
- 8 Heating elements sometimes fail due to problems with wiring or other water heater components. Be sure to check fuses (page 15), inspect contactors (page 36) and check all wiring and connections between the heating elements, contactors, fuses and the power distribution block. Ensure all wiring is correct - see the wiring diagram on the water heater. Ensure all connections are tight and making good contact - replace any wiring, fuses, contactors that are damaged or show signs of excessive wear.
- 9 Close the water heater drain valve and follow the filling instructions in the Maintenance Section of Instruction Manual that came with the water heater.
- 10 Double check all heating element flange bolts to ensure they are properly tightened and check all heating element wiring to ensure it is properly connected and tightened.
- 11 Restore power to the water heater and place the water heater back in service. Check amp draw at all heating elements with a 100% call for heat active. See page 25.

ELEMENT SENSORS

The water heaters covered in this manual monitor heating elements using Element Sensors. Each Element Sensor monitors all the three loops of a heating element - see pages 16 & 17. There will be one Element Sensor for each heating element. IE: water heaters equipped with 5 heating elements will have 5 Element Sensors.

Element Sensor Construction

Element Sensors are an assembly that consists of 3 individual current sensors, a 10 conductor plug and 9 wires that connect between the individual current sensors and the plug. Each current sensor monitors one loop on a heating element. Current sensors are enclosed in a black plastic housing that has a hole in the middle. One of the power wires to each heating element loop is routed through the hole in one of the current sensors. See the images below.

Element Sensor

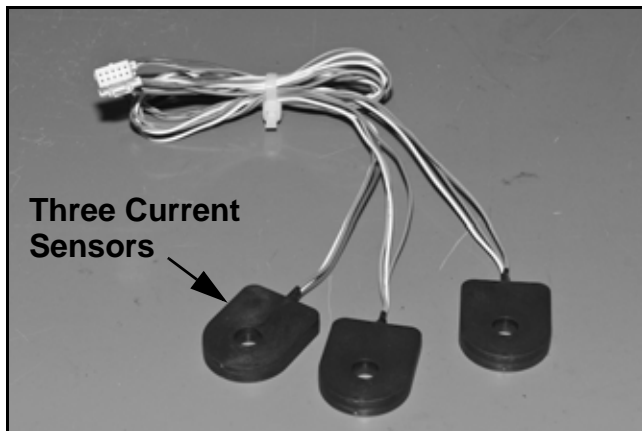

10 Conductor Plug

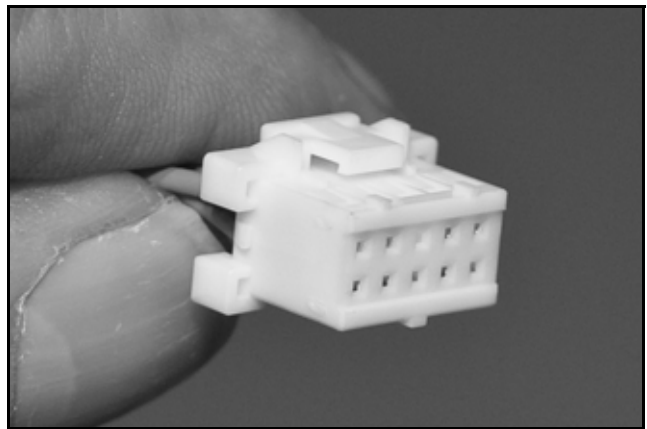

Element Sensor Functions

Working with the Element Sensors the electronic control system provides valuable operational and diagnostic information to aid in servicing.

The electronic control system displays animated Status Icons on the UIM's (User Interface Module) LCD display to indicate which heating elements are being energized and which heating elements are not being energized. The Status Icons will also indicate when a heating element that has been commanded on (energized) by the control system is not drawing current/amperage. See the Desktop Screen on page 58 and the Status Icons Table on page 59.

The electronic control system displays a "No Current Detected" Alert message on the UIM (see pages 55 - 58 and 76) if the control system does not sense current (amperage) from a heating element when expected. IE: a call for heat is active, the control system has commanded all heating elements on - all contactor coils have been energized and the control system is not sensing current from one or more heating element loops.

During Alert conditions the control system allows the water heater to continue heating (other elements may still be working) but prompts the user to have the water heater serviced.

Element Sensor Operation

When current (amperage) flows through a wire in an electrical circuit a magnetic field is developed that radiates out from the wire. The individual current sensors detect this magnetic field. When current flows in a wire routed through the hole in one of the individual current sensors, the sensor is activated and sends a signal back to the CCB confirming the presence of current.

The current sensors require approximately 3 AC amps minimum to activate. An active signal from a current sensor only indicates the minimum current has been sensed, it DOES NOT indicate the amount or level of current is correct for a given heating element/loop.

As explained on the previous page Element Sensors are an assembly that contain three individual current sensors. The three current sensors are installed so that one wire from each loop of each element passes through the hole in a sensor.

The plug from each Element Sensor assembly plugs into one of five sockets on the CCB. The J12, J13, J14, J15 and J16 sockets are for heating elements 1 - 5 respectively depending on how many elements are installed in the water heater. See the images below.

Service Note: The Element Sensors cannot be serviced in the field. If it is determined one of the three individual current sensors in an Element Sensor assembly is defective the entire assembly must be replaced. If the correct amperage through a heating element/loop has been verified with an AC amp meter (see page 25) and the current sensor for that element does not activate and send a signal to the CCB:

- Ensure the Element Sensor plug and socket connection is making good contact.
- On models equipped with more than one heating element secure power to the water heater and try switching Element Sensor plugs between the J12, J13, J14, J15 and J16 sockets to verify the Element Sensor is defective - a “No Current Detected” Alert message and Status Icon indication should “follow” the defective Element Sensor and report a different heating element/loop is not drawing current when current is expected.

CCB Element Sensor Sockets

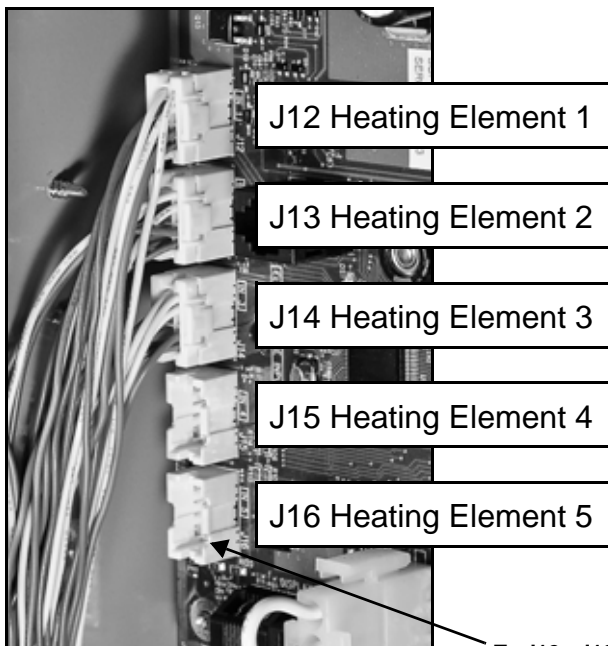

Element Sensor & Element Wire Routing

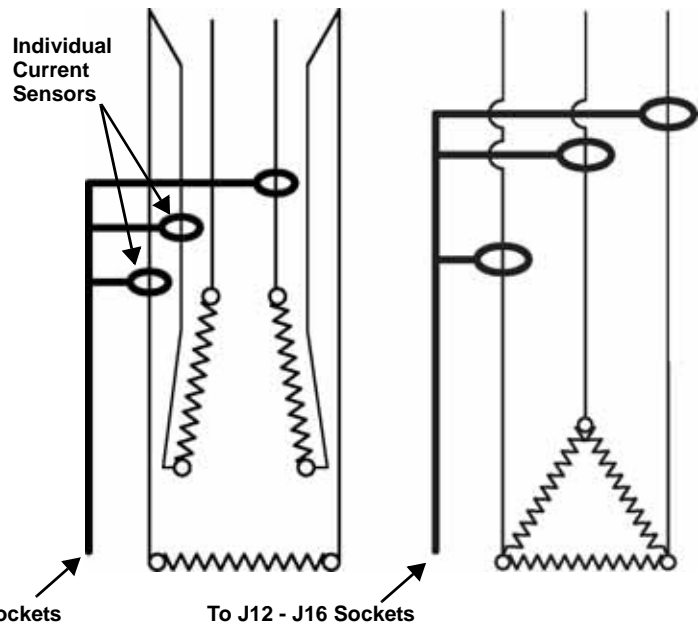

CONTACTORS

This section of the manual provides information on how contactors are constructed, how they work and how to test contactor operation - see pages 8 & 9 for location.

Contactor Construction - How They Work

Magnetic contactors are used to energize and de-energize the heating elements. The water heaters covered in this manual are equipped with either 3 pole or 4 pole contactors the illustrations below show a 3 pole contactor - see Contactor Configurations on page 35 to view 4 pole contactor illustrations. Power is supplied to the heating elements through three or four switches (3 pole and 4 pole contactors) inside the contactor(s). Springs located inside the contactor hold the switch contacts open; the springs are compressed and the spring tension forces or holds the switch contacts in their “normally open” state.

The contactor’s switch contacts are closed by an electromagnetic coil located inside the base of the contactor. When a call for heat is activated the control system sends 120 volts to the contactor’s electromagnetic coil. As current runs through the coil it becomes “magnetized” and overcomes the spring tension holding the switch contacts open. The switch contacts then close which in turn sends power to the heating elements. When the call for heat is satisfied the control system de-energizes the contactor coil and spring tension returns the contacts to their “normally open” position.

3 Pole Contactor Side View

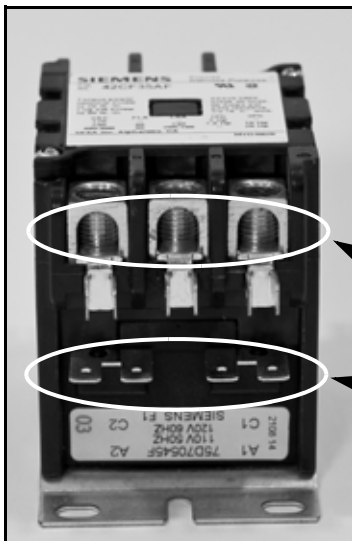

Heating Element Power Circuit Wiring Terminals

Electromagnetic Contactor Coil Wiring Terminals 120 VAC

3 Pole Contactor Internal Wiring

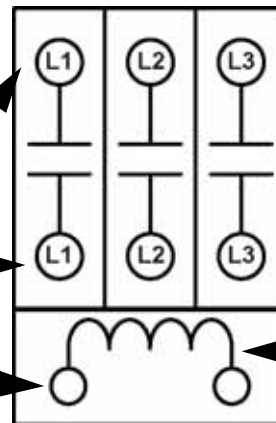

3 Normally Open Switch Contacts

Electromagnetic Contactor Coil

3 Pole Contactor Side View - Cover Plate Removed

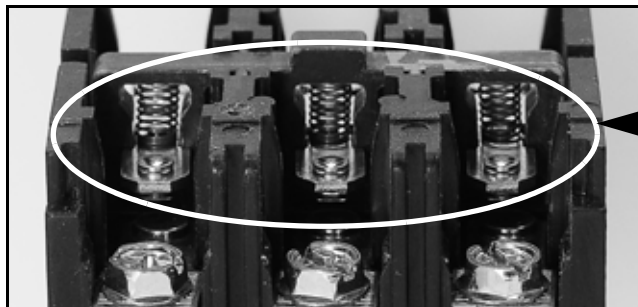

Contactor Springs Hold Contacts Open When Electromagnetic Coil Is Not Energized

Contactor Configurations

Depending on how the water heater was configured in the factory there will be two types of contactors used; 3 pole and 4 pole contactors. The illustrations below show the five standard contactor configurations. There are more detailed heating element connection/wiring diagrams for these standard configurations on pages 18 - 22. Also see the Heating Element Construction and Heating Element Wiring information on pages 16 - 17.

The illustrations below show standard configurations. The water heaters covered by this manual can be custom ordered and may have configurations other than what is shown in this manual. Always refer to the wiring diagram on the water heater.

Three Phase (3Ø) Power

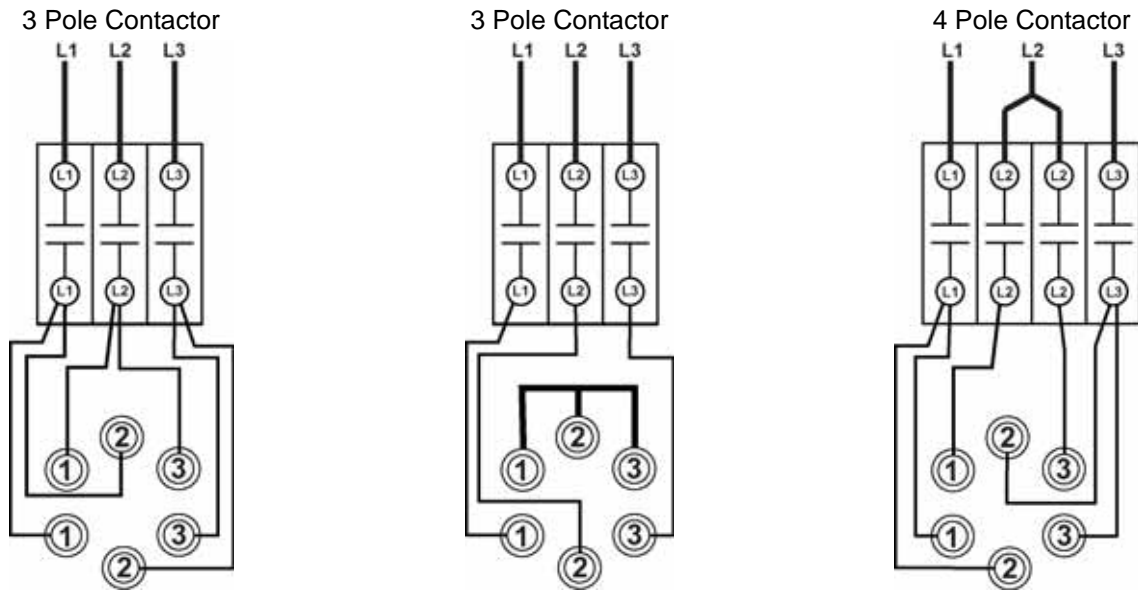

Single Phase (1Ø) Power

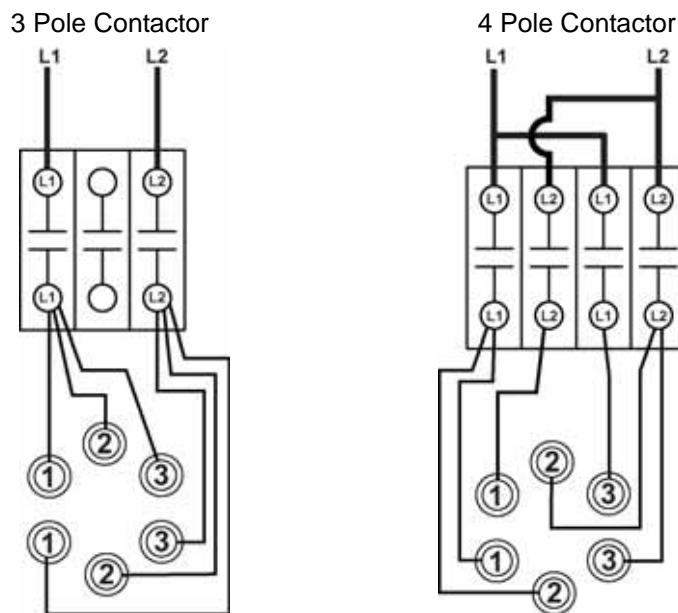

Contactor Inspection

A thorough visual inspection of the contactors should be performed as part of any regular maintenance program and whenever the water heater is being serviced. Refer to the listed Steps and images below for this procedure.

- 1 Secure power to the water heater at the main breaker or disconnect switch.
- 2 Verify with an AC volt meter that there is not any voltage present at the Power Distribution Block (see Figure 2 on page 9) or the contactor on single element models.
- 3 Remove the top cover (two small screws) from the contactor.
- 4 Check for and remove any debris from the area surrounding the switch contacts. IE: ants will occasionally infest the switch contacts and eventually cause the contactor to malfunction.
- 5 Physically test the mechanical spring action of the contactor by depressing the contactor mechanism. If the action is not smooth and/or sticks - replace the contactor.
- 6 Perform a close visual inspection of the switch contacts. The contacts are silver plated and should be smooth. Contactor chatter (see page 6), voltage spikes, arcing, excessive current along with normal wear and tear can cause the normally smooth surface of the contacts to become burnt, pitted and damaged. In extreme cases the contacts can “weld” together and permanently close the contacts. The switch contacts are not replaceable. If the contacts show signs of excessive wear or damage - replace the contactor.
- 7 Replace the top cover on all contactors when inspection is complete.

Top View Cover Plate On
3 Pole Contactor



Side View Cover Plate Removed
4 Pole Contactor

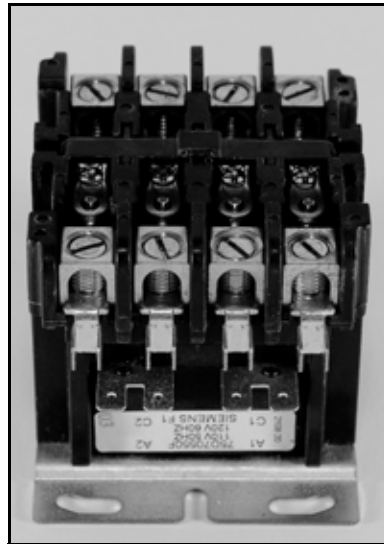

Physically Operate Mechanical Spring Action Of Contactor
Press Down Here

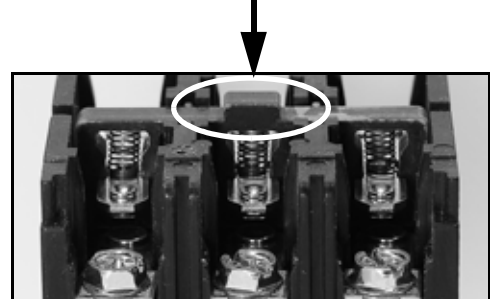

Perform Close Visual Inspection Of Switch Contacts

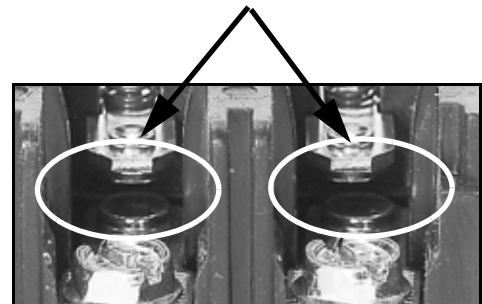

Contactor Coil Voltage Test - At Contactor

This test procedure will measure contactor coil voltage at the contactor.

- 1 Ensure tank temperature is less than 100°F/38°C - dump water to lower tank temperature if necessary.
- 2 Adjust the temperature settings to ensure a call for heat is active for all heating elements. Raise the Operating Set Point to 140°F or higher. Set all Differentials at 2°F - see pages 61 and 62.
- 3 Using an AC volt meter; set the volt meter to an AC voltage range just above 120 VAC.
- 4 Touch the two volt meter probes to the contactor coil wiring terminals on the contactor. Repeat this procedure at each contactor being tested. There should be approximately 120 volts present between the two terminals.

Service Warning: Be extremely careful when performing this test procedure; volt meter probes are routed between wires in tight proximity - there will be high voltage present at all terminals and wiring to the contactors.

If there is no voltage present proceed to the Contactor Coil Voltage - At CCB test on page 38.

If the measured voltage is considerably less than 120 volts and/or the contactors chatter (open and close rapidly) ensure the Control Circuit Transformer is wired correctly - see pages 39 & 40.

If the measured voltage is approximately 120 volts the contactor should close it's switch contacts. If the contacts are closed the contactor coil is operating properly.

If the measured voltage is approximately 120 volts and the contactor's switch contacts do not close - the contactor is defective and must be replaced. When replacing a contactor that has failed in this way check all wiring between the contactor coil and the J4 or J17 wiring terminals on the CCB (see pages 50 - 52) for pinched or shorted wires - repair or replace damaged wiring as necessary.

Service Note: A continuity test can also be performed on contactor coils to determine if the failure is due to an open coil winding. Secure power to the water heater at the main breaker or disconnect switch, disconnect both wires to the contactor coil and check for continuity between the two terminals using an ohm meter. If a contactor has an open coil the contactor must be replaced. Check all wiring between the contactor coil and the J4 or J17 wiring terminals on the CCB (see pages 50 - 52) for pinched or shorted wires - repair or replace damaged wiring as necessary.

4 Pole Contactor Side View



3 Pole Contactor Side View

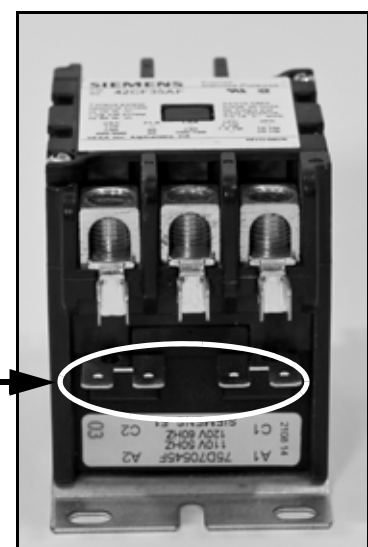

Electromagnetic
Contactor Coil Wiring
Terminals 120 VAC

Contactor Coil Voltage Test - At CCB

This test procedure will measure contactor coil voltage where it originates at the J4 & J17 wiring terminals on the CCB. See page 50 for the CCB's J4 wiring terminal location.

- 1 Ensure tank temperature is less than 100°F/38°C - dump water to lower tank temperature if necessary.
- 2 Adjust the temperature settings to ensure a call for heat is active for all heating elements. Raise the Operating Set Point to 140°F or higher. Set all Differentials at 2°F - see pages 61 and 62.
- 3 Using an AC volt meter; set the volt meter to an AC voltage range just above 120 VAC.
- 4 Touch one of the two volt meter probes to the ground wire connection on the water heater. Touch the other volt meter probe to the CCB's J4 OUT 1 wiring terminal. See the images below. On water heaters equipped with more heating elements also check between the ground connection and the CCB: J4 OUT 2, J4 OUT 3, J17 OUT 4 and J17 OUT 5 wiring terminals to ensure the CCB is sending 120 VAC to the other contactor coils. Measure and record voltage output for all contactors at the CCB - up to 5 voltage readings on models so equipped.

Service Warning: Be extremely careful when performing this test procedure - there will be high voltage present at many terminals and wiring connections in the surrounding area.

- 5 If the measured voltage(s) were approximately 120 volts the CCB is operating properly.
- 6 If the measured voltage(s) were zero or considerably less than 120 volts call the toll free Technical Support phone number listed on the back cover of this manual for further assistance.

Checking Contactor Coil Voltage at the CCB's J4 & J17 Wiring Terminals

CCB J4 & J17 Wiring Terminals

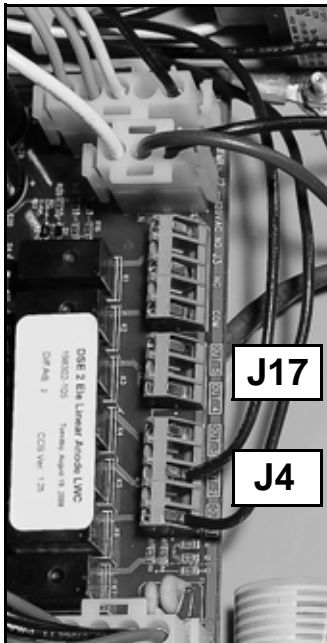

CCB's J4 OUT 1 Terminal

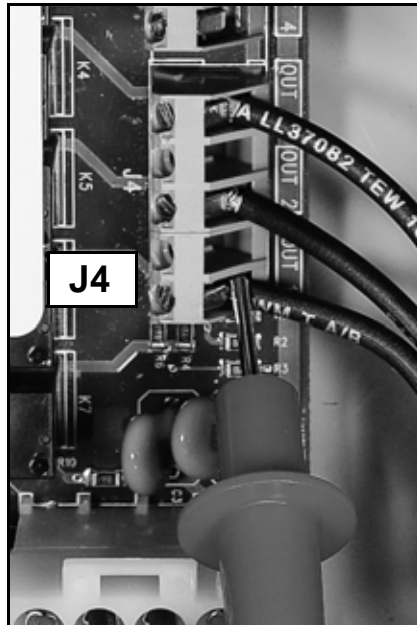

Water Heater Ground Connection

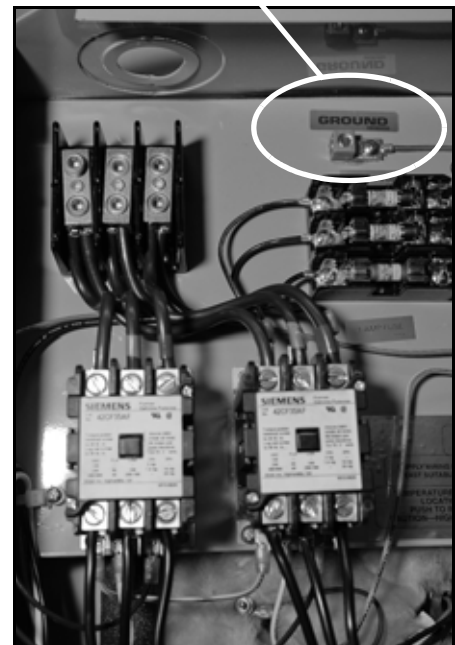

TRANSFORMERS

This section of the manual provides information on how to check wiring and test the multiple tap 120 VAC Control Circuit Transformer and the 24 VAC transformer - see Figures 1 and 2 on pages 8 & 9 for location of the transformers.

Service Note: There are two different 120 VAC transformers used on the water heaters covered in this manual. One is used on water heaters factory configured for 208/240/277 volts. The other is used on 380/480 volt models. Both are multi tap transformers and primary winding wiring configuration is similar.

120 VAC Transformer Wiring - 208/240/277 Volt Models

This is a multiple or “multi” tap transformer that can accept 3 different input voltages to its primary winding. This transformer outputs 120 VAC power from its secondary winding which powers the CCB (page 50) and the contactor coils. The input power wiring to the primary winding of this transformer must be configured to match the power supply voltage to the water heater. Incorrect wiring can cause output voltage from the transformer’s secondary winding to be too low or too high. This can cause “contactor chatter” (contacts open and close rapidly) and may permanently damage the contactors and/or the CCB. The instructions below show how to properly configure the input power wiring to the transformers primary winding.

- 1 Determine power supply voltage to the water heater - see pages 12 - 14. Ensure the power supply wiring to the 120 VAC transformer’s primary winding are connected to the proper terminals as shown in the table below.
- 2 Only one wire needs to be moved on the transformer’s primary winding terminals to configure for a different voltage. Do not move or change the wire connected to the H1 terminal on the primary winding. Do not move or change either wire at the secondary winding X1 or X2 connections.

WATER HEATER POWER SUPPLY VOLTAGE	PRIMARY WINDING CONNECTIONS
208 VAC	H1 Common & H2 (208)
240 VAC	H1 Common & H3 (240)
277 VAC	H1 Common & H4 (277)

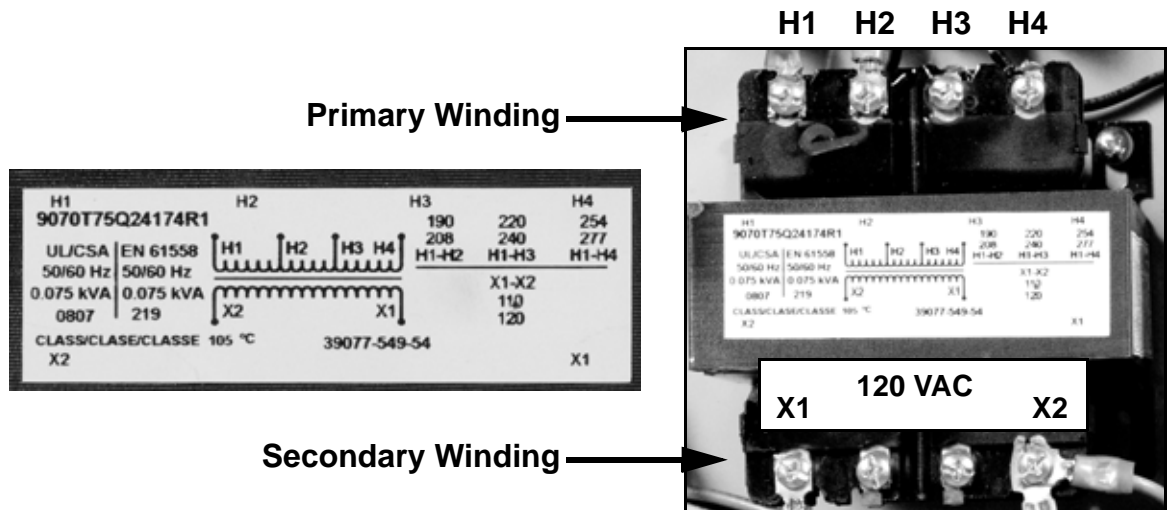

120 VAC Transformer Wiring - 480 Volt Models

This is a multiple or “multi” tap transformer that can accept 2 different input voltages to its primary winding. This transformer outputs 120 VAC power from its secondary winding which powers the CCB (page 50) and the contactor coils. The input power wiring to the primary winding of this transformer must be configured to match the power supply voltage to the water heater. Incorrect wiring can cause output voltage from the transformer’s secondary winding to be too low or too high. This can cause “contactor chatter” (contacts open and close rapidly) and may permanently damage the contactors and/or the CCB. The instructions below show how to properly configure the input power wiring to the transformer’s primary winding.

Service Note: The 380 Volt H2 tap is used for international applications. Ensure you do not connect the second wire to the H2 tap for standard 480 volt applications.

- 1 Determine power supply voltage to the water heater - see pages 12 - 14. Ensure the power supply wiring to the 120 VAC transformer’s primary winding are connected to the proper terminals as shown in the table below.
- 2 Only one wire needs to be moved on the transformer’s primary winding terminals to configure for a different voltage. Do not move or change the wire connected to the H1 terminal on the primary winding. Do not move or change either wire at the secondary winding X1 or X2 connections.

WATER HEATER POWER SUPPLY VOLTAGE	PRIMARY WINDING CONNECTIONS
380 VAC	H1 Common & H2 (380)
480 VAC	H1 Common & H3 (480)

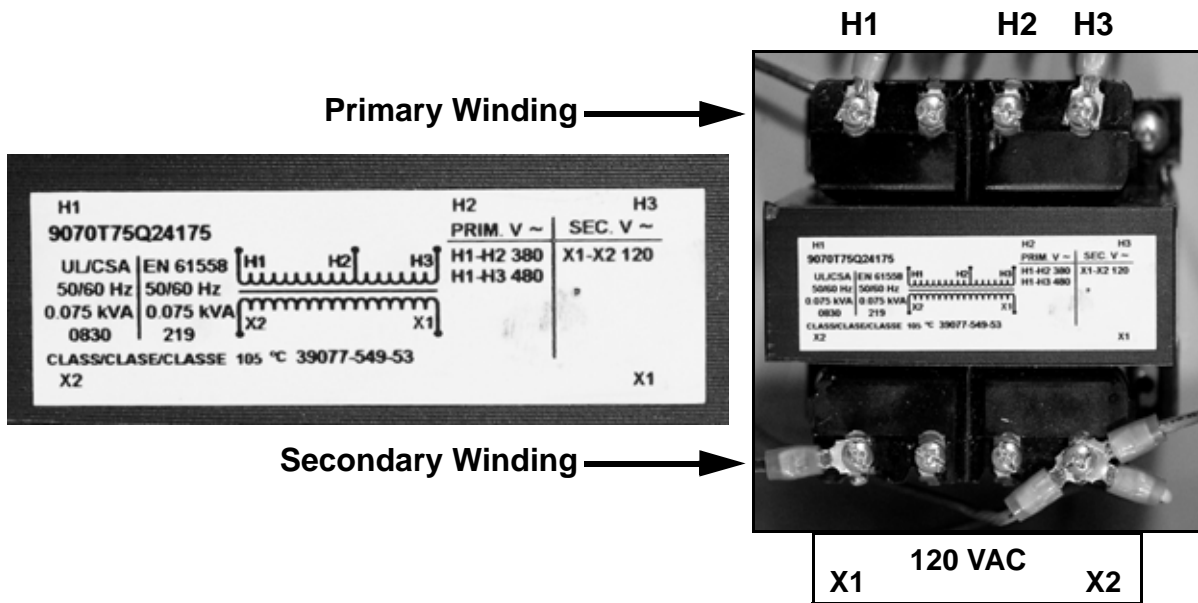

120 VAC Control Circuit Transformer Test

- 1 Ensure the main breaker or disconnect switch is turned on.
- 2 Verify with an AC volt meter that proper voltage is present at the Power Distribution Block or the contactor on single element models (see Figures 1 and 2 on pages 8 & 9 and pages 12 - 14).
- 3 **Check Primary Winding Voltage:** Using an AC volt meter; set the volt meter to an AC voltage range above the expected voltage (600 VAC or higher range initially). Touch the two volt meter probes between the control circuit transformer's primary winding H1 common terminal and the other primary winding terminal with a power wired connected to it as shown in the "Primary Winding Voltage Test" image below - see pages 39 & 40. Voltage between these two terminals should match the water heater's power supply voltage. If the voltage at the primary winding terminals of the transformer matches the water heater's power supply voltage the primary winding is being powered correctly. If the voltage measured is zero volts or considerably less or more than the water heater's power supply voltage:
 - Check the control circuit fuses - see the Fuse test procedure on page 15.
 - Check the wiring between the 120 VAC Control Circuit Transformer's primary winding and the Control Circuit Fuses see Figures 1 and 2 on pages 8 & 9 for location - ensure wiring is correct and connections are tight and making good contact.
 - Check the wiring between the Control Circuit Fuses and the Power Distribution Block or contactor on single element models - ensure wiring is correct and connections are tight and making good contact.
 - Verify 120 VAC Control Circuit Transformer wiring is correct - see pages 39 & 40.
- 4 **Check Secondary Winding Voltage:** Using an AC volt meter; set the volt meter to an AC voltage range just above 120 VAC. Touch the two volt meter probes between the Control Circuit Transformer's secondary winding X1 and X2 terminals as shown in the "Secondary Winding Voltage Test" image below. There should be approximately 120 VAC present between these two terminals. If the voltage measured is approximately 120 VAC the Control Circuit Transformer is operating properly. If the voltage measured is zero volts or considerably less or more ($\pm 10\%$) than 120 VAC AND all Steps above have been completed and the results were successful - replace the Control Circuit Transformer. When replacing the Control Circuit Transformer check all wiring to and from the transformer for pinched or shorted wires - repair or replace damaged wiring as necessary.

Service Note: A continuity test can also be performed on the Control Circuit Transformer primary and secondary windings to determine if either winding is an open circuit. Secure power to the water heater. Disconnect all wiring to the transformer. Using an ohm meter check for continuity between the terminals on the primary and secondary windings checked in Steps 3 and 4 above.

Primary Winding Voltage Test

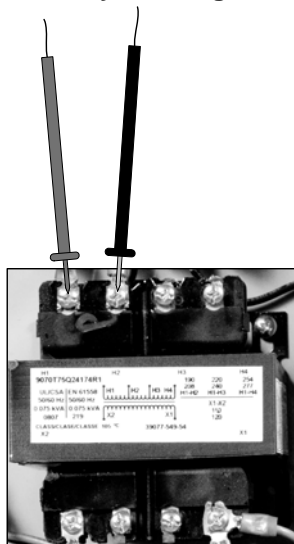

Secondary Winding Voltage Test

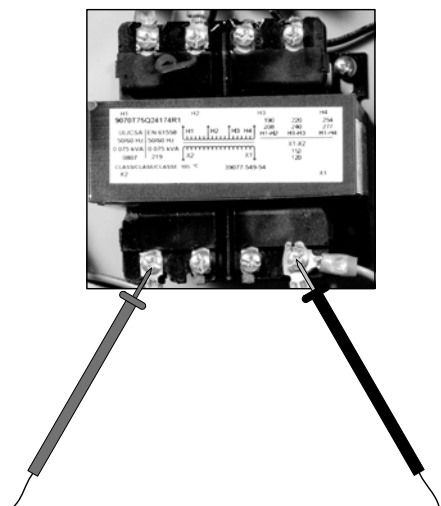

24 VAC Transformer Test

- 1 Ensure the main breaker or disconnect switch is turned on.
- 2 Verify with an AC volt meter that proper voltage is present at the Power Distribution Block or the contactor on single element models (see Figures 1 and 2 on pages 8 & 9 and pages 12 - 14).
- 3 **Check Primary Winding Voltage:** Using an AC volt meter; set the volt meter to an AC voltage range just above 120 VAC. With the J1 plug installed in the J1 socket on the CCB (page 50) insert the two volt meter probes into pins 1 & 3 of the J1 plug as shown in the “Primary Winding Voltage Test” image below. Volt meter probes may have to be pressed firmly into the plug to make contact with the metal conductors inside. Voltage should be approximately 120 VAC. If the voltage measured is approximately 120 VAC the primary winding is being powered correctly. If the voltage measured is zero volts or considerably less or more ($\pm 10\%$) than 120 VAC:
 - Check the J1 plug/socket connections on the CCB for wear or damage. Ensure they are mating properly and providing good contact - see page 50.
 - Check the 120 VAC Control Circuit Transformer to ensure it is wired correctly and outputting the correct voltage - see pages 39 - 41.
 - Ensure there is 120 VAC being supplied to the CCB - see page 54.
 - Call the toll free technical support phone number on the back cover of this manual for further assistance if all the procedures above have been performed and 120 VAC is still not present at pins 1 & 3 of the J1 socket/plug on the CCB.
- 4 **Check Secondary Winding Voltage:** Using an AC volt meter; set the volt meter to an AC voltage range just above 24 VAC. With the J1 plug installed in the J1 socket on the CCB (page 50) insert the two volt meter probes into pins 4 & 5 of the J1 plug as shown in the “Secondary Winding Voltage Test” image below. Volt meter probes may have to be pressed firmly into the plug to make contact with the metal conductors inside. Voltage should be approximately 24 VAC. If the voltage measured is approximately 24 VAC the transformer is operating properly. If the voltage measured is zero volts or considerably less or more ($\pm 5\%$ expected) than 24 VAC:
 - Check the J1 plug/socket connections on the CCB for wear or damage. Ensure they are mating properly and providing good contact - see page 50.
 - Check all wiring (four wires) between the J1 plug and the 24 VAC transformer - see Figures 1 & 2 on pages 8 & 9 for location. Ensure wiring is not pinched or shorted and continuous to the 24 VAC secondary winding - repair or replace damaged wiring as necessary.
 - If all the above procedures have been performed and there is still not 24 VAC present at pins 4 & 5 of the J1 plug - replace the 24 VAC transformer. When replacing the transformer check all wiring to and from the transformer for pinched or shorted wires - repair or replace damaged wiring as necessary.

Primary Winding Voltage Test

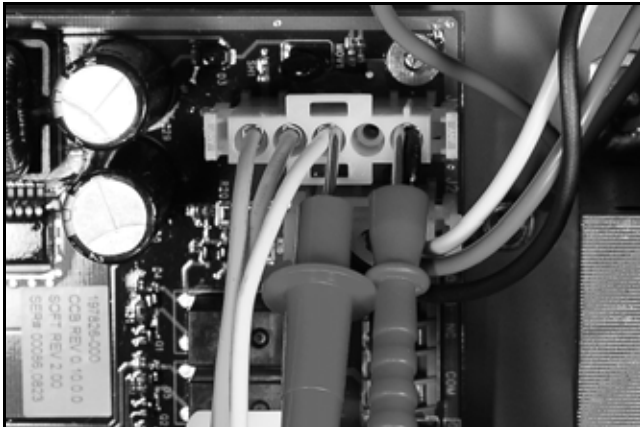

Secondary Winding Voltage Test

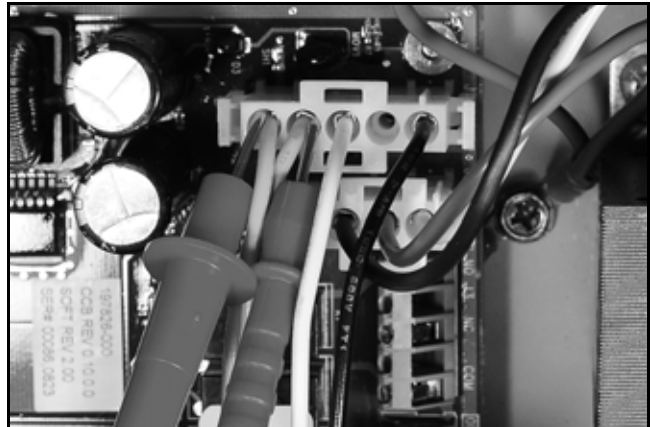

IMMERSION TEMPERATURE PROBE

This section of the manual provides information on how test the Immersion Temperature Probe - see Figures 1 & 2 on pages 8 & 9 for location. The Immersion Temperature Probe contains the ECO (energy cut out) and a Temperature Sensor. The Immersion Temperature Probe plugs into the CCB at the J5 socket - see pages 50 - 52 for location.

ECO High Temperature Limit Switch

The ECO (energy cut out) is a high temperature limit switch designed to protect against excessively high water temperatures inside the water heater. The ECO is a normally closed switch located inside the Immersion Temperature Probe (two red wires). The ECO temperature setting is non adjustable; the contacts open at 202°F/94°C and will close at approximately 140°F/60°C.

The control system constantly monitors the state of the ECO switch contacts. If the ECO activates (contacts open) due to abnormally high water temperature the control system will lock out and display a “Energy Cut Out (ECO)” Fault message on the UIM (page 78). Voltage to the contactor coils (pages 37 & 38) and heating elements is terminated to prevent further heating operation.

Should the ECO activate, the water temperature must drop below 140°F/60°C before the control system can be reset. Once the water temperature has cooled below this point the power supply to the water heater must be turned off and on again to reset the control system.

Temperature Sensor

The temperature sensor located inside the Immersion Temperature Probe is a “thermistor” (two black wires). Thermistors are thermally sensitive resistors. As the water temperature rises the resistance (in ohms) of the sensor will decrease; as the temperature falls the resistance will increase - see the Temperature Sensor Resistance Data table on page 44. The control system interprets the changes in resistance as changes in water temperature.

The control system constantly monitors the temperature sensor (thermistor) for temperature. The control system is programmed to declare a Fault condition if the resistance of the temperature sensor drops below 390 ohms (shorted) or above 56,000 ohms (open).

If the resistance of the temperature sensor is below 390 ohms the control system will lock out and display a “Temp Probe Short” Fault message on the UIM (page 58). If the resistance of the temperature sensor is above 56,000 ohms the control system will lock out and display a “Temp Probe Open” Fault message on the UIM. Voltage to the contactor coils (see pages 37 & 38) and heating elements is terminated during lock out to prevent further heating operation.

If the control system locks out the condition that caused the lock out must be corrected before the control system can be reset by cycling power off and on again.

Immersion Temperature Probe



Temperature Sensor Resistance Test

- 1 Secure power to the water heater at the main breaker or disconnect switch.
- 2 Unplug the J5 plug from the CCB - see page 50 for location.
- 3 Using an ohm meter: set the ohm meter range to a scale above 30,000 ohms initially.
- 4 Touch the ohm meter probes between the two middle pins (black wires) of the J5 plug end as shown in the image below. Compare the measured resistance value (ohms) to the values given in the resistance data table below. Temperature probes are very reliable and should only be replaced when:
 - The resistance test indicates an “open” (infinite resistance) or a “direct short” (no resistance) circuit.
 - The nature of the service problem is temperature control and the resistance readings are considerably ($\pm 25\%$) different than the values in the table here at the given temperature.

Checking Temperature Sensor Resistance

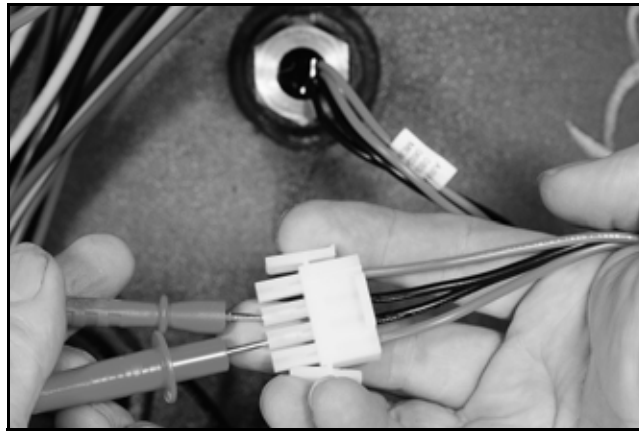

Temperature Sensor Resistance Data

WATER TEMPERATURE		RESISTANCE IN OHMS
Celsius	Fahrenheit	
3°	40°	26,435
21°	70°	11,974
38°	100°	5,862
49°	120°	3,780
55°	130°	3,066
60°	140°	2,503
71°	160°	1,698
82°	180°	1,177

Temperature Sensor DC Voltage Test

- 1 Ensure the main breaker or disconnect switch is turned on.
- 2 Verify the CCB has the correct input voltage at the J2 socket and is properly grounded - perform the "Checking Power and Ground To The CCB" tests on page 54.
- 3 Unplug the J5 plug from the CCB (note: the control system will lock out and display "Temp Probe Open" Fault message on the UIM when the J5 plug is removed - cycle power off and reinstall J5 plug when tests are complete). Using a "DC" (direct current) volt meter check for DC voltage between pins 2 & 3 of the J5 socket as shown in the "DC Voltage To Temperature Sensor" image below.
 - If the measured voltage is 5 VDC the sensor is powered correctly. If there is not 5 VDC call the toll free Technical Support phone number listed on the back cover of this manual for further assistance.

ECO Continuity Test

- 1 Secure power to the water heater at the main breaker or disconnect switch.
- 2 Unplug the J5 plug from the CCB - see page 50 for location.
- 3 Ensure tank temperature is less than 100°F/38°C - dump water to lower tank temperature if necessary.
- 4 Using an ohm meter; set the Ohm meter to it's lowest resistance range (< 200) or to an audible beep continuity test setting if so equipped.
- 5 Touch the ohm meter probes between the two outside pins (red wires) of the J5 plug end as shown in the "Checking ECO Switch Continuity" image below.
 - If the ohm meter shows continuity (closed circuit) between the two outside pins (red wires) of the J5 plug end the ECO switch has reset properly. If the control system continues to lock out displaying the "Energy Cut Out (ECO)" Fault message with continuity through the ECO present call the toll free Technical Support phone number listed on the back cover of this manual for further assistance.
 - If the ohm meter shows no continuity (open circuit) between the two outside pins (red wires) of the J5 plug end and the tank temperature is known to be at or below 100°F/38°C - replace the Immersion Temperature Probe. Secure power to the water heater and drain the water heater before replacing the probe - follow the draining and filling instructions in the maintenance section of the Instruction Manual that came with the water heater.
 - If the control system continues to lock out displaying the "Energy Cut Out (ECO)" Fault message and the water temperature inside the water heater is becoming excessive (at or above 202°F/94°C) check contactors (pages 34 - 38) to ensure they are not stuck closed and check for voltage at all heating elements (page 26) during standby mode. Check water system piping; ensure heat is not being added by any other heating appliances or heat sources. If all these tests have been performed and the control system continues to lock out displaying the "Energy Cut Out (ECO)" Fault message call the toll free Technical Support phone number listed on the back cover of this manual for further assistance.

DC Voltage To Temperature Sensor

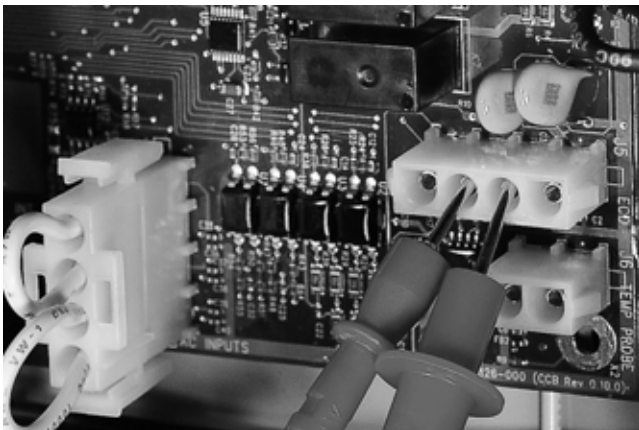

Checking ECO Switch Continuity

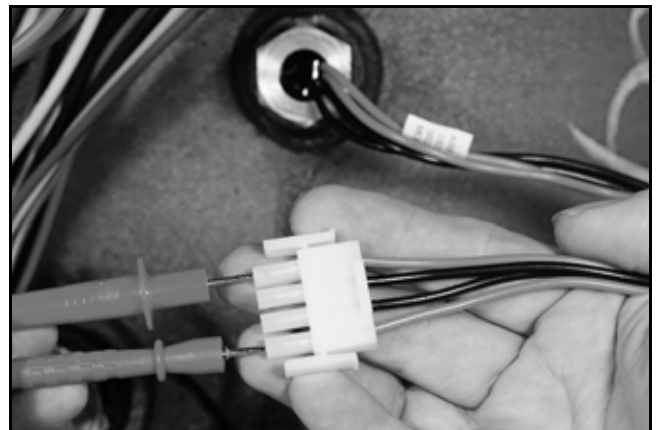

ECO Voltage Test

- 1 Ensure the main breaker or disconnect switch is turned on.
- 2 Verify the CCB has the correct input voltage at the J2 socket and is properly grounded - perform the Checking Power and Ground To The CCB tests on page 54.
- 3 Using an AC volt meter; set the volt meter to an AC voltage range just above 120 VAC.
- 4 **Check for 120 VAC to the ECO:** With the J5 plug installed in the J5 socket on the CCB (page 50) insert one of the two volt meter probes into pin 1 of J5 plug as shown in the “120 VAC To ECO” image below. Volt meter probe may have to be pressed firmly into the plug to make contact with the metal conductor inside. Touch the other volt meter probe to the ground wire connection on the water heater. The measured voltage should be approximately 120 VAC.
 - If the measured voltage is approximately 120 VAC proceed to Step 5.
 - If the measured voltage is zero or considerably less or more than 120 VAC and all Steps above have been performed call the toll free Technical Support phone number listed on the back cover of this manual for further assistance.
- 5 **Check for 120 VAC from the ECO:** With the J5 plug installed in the J5 socket on the CCB (page 50) insert one of the two volt meter probes into pin 1 of J5 plug as shown in the “120 VAC From ECO” image below. Volt meter probe may have to be pressed firmly into the plug to make contact with the metal conductor inside. Touch the other volt meter probe to the ground wire connection on the water heater. The measured voltage should be approximately 120 VAC.
 - If the measured voltage is approximately 120 VAC the ECO switch is closed, the control system should not be declaring an ECO Fault condition. If the control system continues to lock out displaying the “Energy Cut Out (ECO)” Fault message in this condition call the toll free Technical Support phone number listed on the back cover of this manual for further assistance.
 - If the measured voltage is zero volts or considerably less than 120 VAC perform the “ECO Continuity Test” on page 45.

120 VAC To ECO



120 VAC From ECO

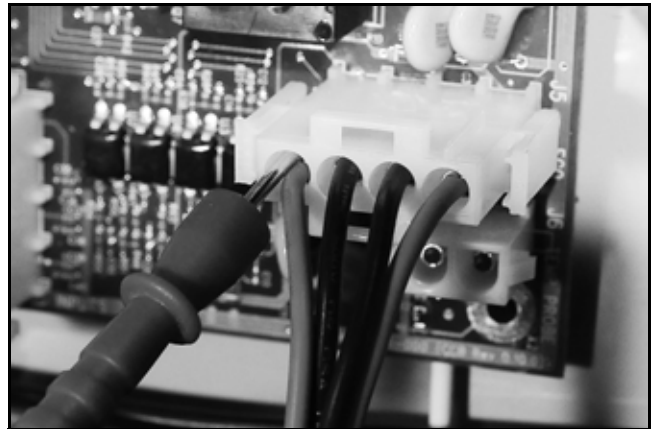

LWCO - LOW WATER CUT OFF

The water heaters covered in this manual are equipped with a LWCO (low water cut off) safety device. The control system monitors a LWCO probe (see the images below) constantly to ensure the water level inside the water heater remains at or above the level where the probe is installed. The LWCO probe is installed in a threaded fitting in the water heater's storage tank. See Figures 1 & 2 on pages 8 & 9 for location. The LWCO probe is wired to the CCB's J10 plug - see pages 50 - 52 for location and identification.

LWCO Operation

When the water heater is properly filled with water the end of the LWCO probe is in direct contact with the water. The CCB emits a low voltage to the LWCO probe and monitors electrical current flowing through the probe. If the water level in the water heater remains at or above the level of the probe current will flow from the probe end through the water to the water heater's storage tank which is grounded.

If the water level drops below the LWCO probe the control system will declare a LWCO Fault condition and lock out - see page 79. Voltage to the contactor coils (pages 37 & 38) and heating elements is terminated to prevent further heating operation.

Inspection and Cleaning

Over time calcium and lime deposits will adhere to the end of the LWCO probe depending on water hardness, water usage and water temperature. Heavy calcium/lime accumulation will diminish the current flow through the probe and cause LWCO Fault conditions. Inspection and cleaning of the LWCO should be performed periodically and any time the control system declares a LWCO Fault condition.

- 1 Secure power to the water heater - follow the draining instructions in the maintenance section of the Instruction Manual that came with the water heater to drain the tank.
- 2 Disconnect wiring to the LWCO probe and remove it from the water heater.
- 3 Closely inspect the LWCO for any damage or cracks in the ceramic insulator - replace the LWCO probe if any cracks or damage is noticed.
- 4 Clean any calcium/lime deposits from the probe end by gently scraping and using steel wool. Reinstall the LWCO probe, reconnect wiring to the probe.
- 5 Follow the filling instructions in the maintenance section of the Instruction Manual that came with the water heater. Restore power and place the water heater back in service.

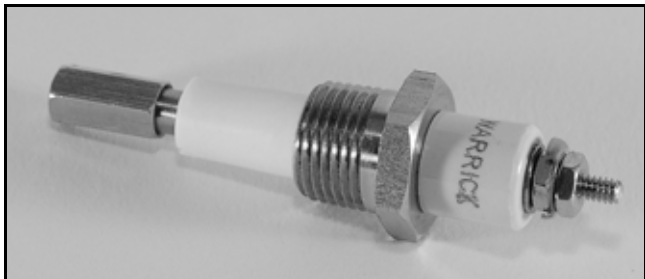

POWERED ANODE ROD

All of the water heaters covered in this manual are equipped with a standard anode rod. Some of the water heaters covered in this manual are also equipped with a powered anode rod. See pages 8 & 9 for location. Both types of anode rods are designed to reduce tank corrosion (rusting) that naturally occurs when water comes into contact with steel. See the maintenance section of the Instruction Manual that came with the water heater for standard anode rod maintenance procedures.

Rust & Corrosion

Rusting & corrosion of steel is an electrochemical process; electrical current flows between the exposed steel of the storage tank and the water inside. All tanks are glass lined but there will be exposed areas around spuds/threaded fittings where glass coating is not possible.

Powered Anode Rod Operation

A powered anode rod (see images below) is installed into a threaded fitting in the water heater's storage tank. DC current flows from the CCB's J10 socket (page 50) to the powered anode and through the water to the water heater's storage tank which is grounded. The DC current interrupts the electrical flow of the corrosion process which in turn reduces corrosion. The control system adjusts and monitors current flow through the anode. If there is an operational problem the control system will declare an Alert condition - see page 80.

Inspection and Cleaning

Over time calcium and lime deposits may adhere to the end of the anode rod depending on water hardness, water usage and water temperature. Heavy calcium/lime accumulation will diminish the current flow through the anode rod and may cause anode rod Alert conditions. Powered anode rods should be inspected/cleaned periodically or anytime the control system declares a powered anode Alert condition - see page 80.

- 1 Secure power to the water heater - follow the draining instructions in the maintenance section of the Instruction Manual that came with the water heater to drain the tank.
- 2 Disconnect wiring to the powered anode rod and remove it from the water heater.
- 3 Closely inspect the powered anode for any damage - replace the anode if damaged.
- 4 Clean any calcium/lime deposits from the powered anode by gently scraping and using steel wool. Reinstall the powered anode and reconnect the wiring.
- 5 Follow the filling instructions in the maintenance section of the Instruction Manual that came with the water heater. Restore power and place the water heater back in service.

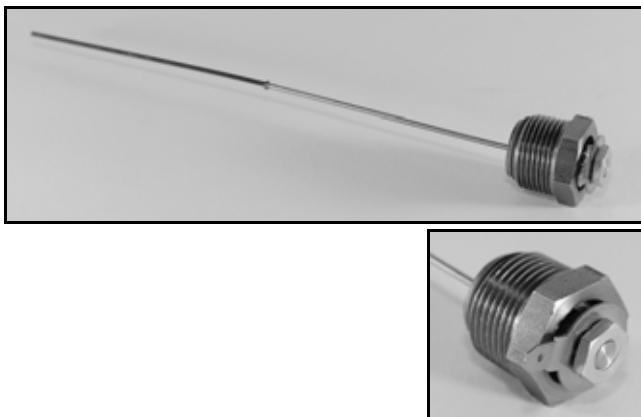

ELECTRONIC CONTROLS

Introduction

This section of the manual covers the electronic controls. The control system includes a **CCB** (Central Control Board), a **UIM** (User Interface Module) and a **Button Pad Overlay**.

The control system constantly monitors and safely controls heating elements, water temperature and other functions of the water heater. Information is continuously reported to the user through text and icons on the liquid crystal display (LCD) portion of the UIM. Users can navigate through multiple control system menus to view operational information and change user settings.

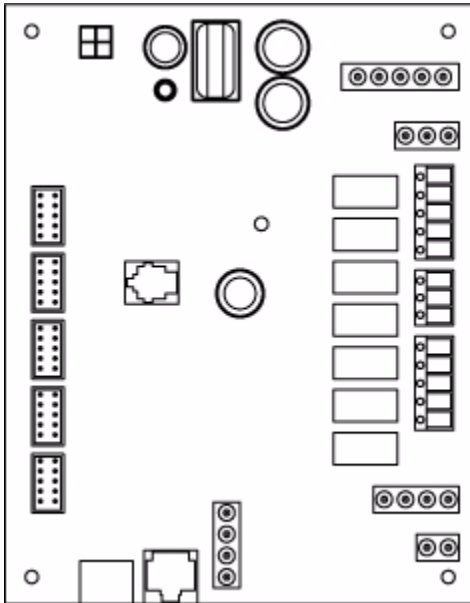

CCB (Central Control Board)

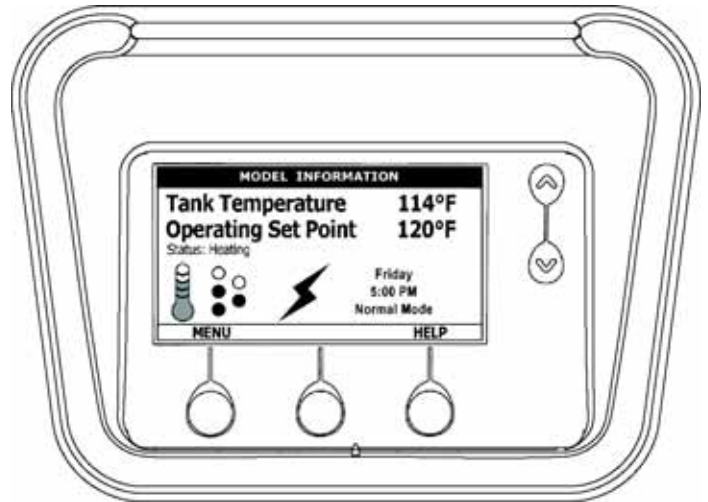

UIM (User Interface Module)

CCB - Central Control Board

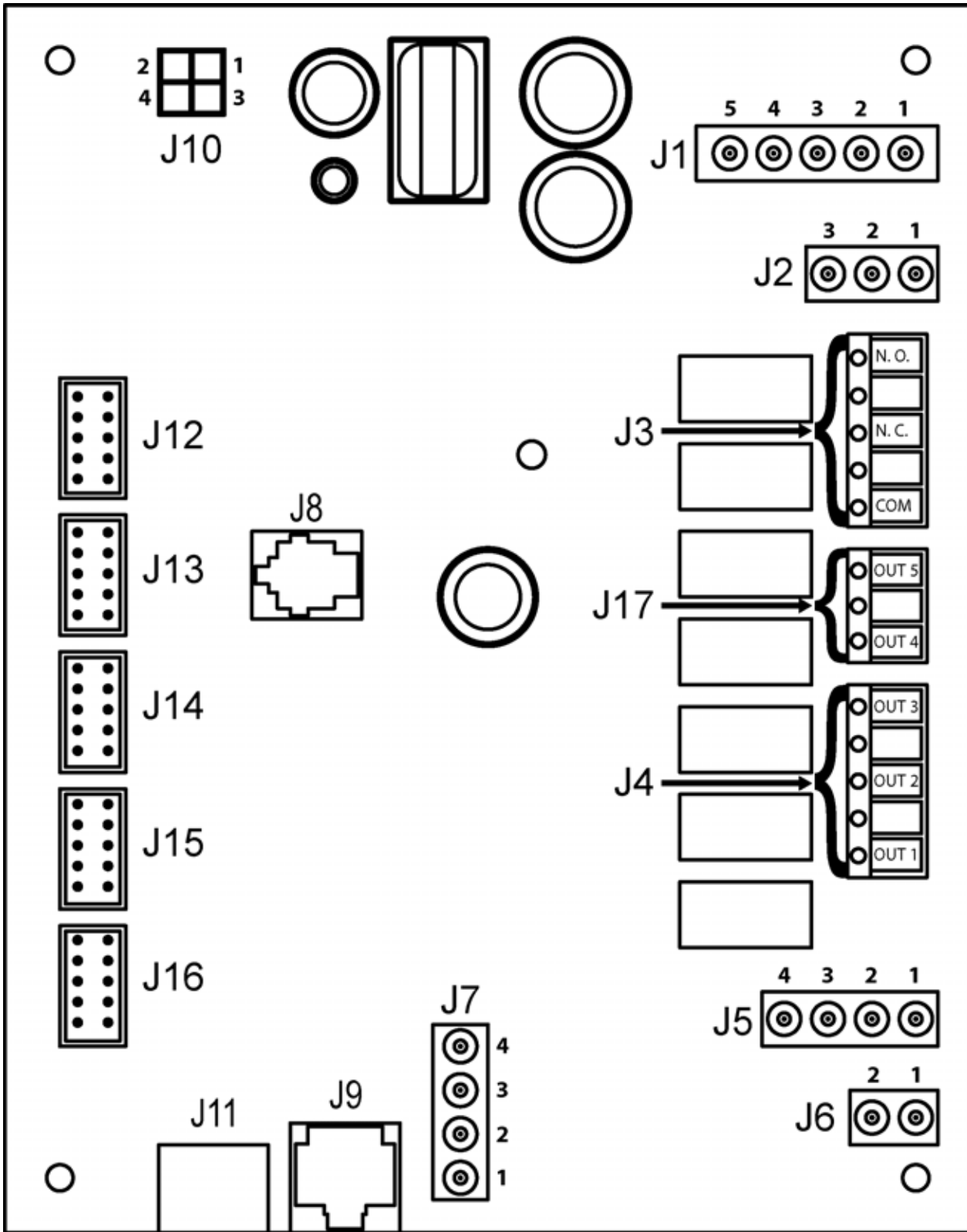

CCB Socket & Wiring Terminal Identification

Refer to the illustration on page 50 for physical location of the sockets and wiring terminals.

J1 Socket - Transformer

PIN #	DESCRIPTION
1	120 VAC hot to transformer
2	Not used
3	120 VAC neutral to transformer
4	24 VAC out from transformer
5	24 VAC out from transformer

J2 Socket - 120 VAC Power Supply

PIN #	DESCRIPTION
1	120 VAC hot
2	Earth Ground
3	120 VAC neutral

J3 Wiring Terminals - Alarm Output Relay (see page 68)

TERMINAL	DESCRIPTION
N. O.	Dry Contact Output - Normally Open Terminal Alarm Output Relay
N. C.	Dry Contact Output - Normally Closed Terminal Alarm Output Relay
COM	Dry Contact Output - Common Terminal Alarm Output Relay

J4 Wiring Terminals - Contactor Coils

TERMINAL	DESCRIPTION
OUT 1	120 VAC hot to Heating Element #1 Contactor Coil
OUT 2	120 VAC hot to Heating Element #2 Contactor Coil - if so equipped
OUT 3	120 VAC hot to Heating Element #3 Contactor Coil - if so equipped

J5 Socket - Immersion Temperature Probe/ECO

PIN #	DESCRIPTION
1	ECO (energy cut out) 120 VAC hot out (red wire)
2	Temperature probe (thermistor) +5.0 VDC (black wire)
3	Temperature probe (thermistor) -5.0 VDC (black wire)
4	ECO (energy cut out) 120 VAC return (red wire)

J6 Socket - Not Used

J7 Socket - Enable / Disable Circuits 1 & 2 (see pages 53 & 63)

PIN #	DESCRIPTION
1	Enable/Disable circuit 1
2	Enable/Disable circuit 1
3	Enable/Disable circuit 2
4	Enable/Disable circuit 2

J8 Socket - Not Used

J9 Socket - Not Used

J10 Socket - LWCO & Powered Anode Rod

PIN #	DESCRIPTION
1	Not Used
2	Powered Anode Rod Output (on models so equipped)
3	Not Used
4	LWCO (Low Water Cut Off) Input

J11 Port - Communication Port - UIM Display (user interface module)

J12 Socket - Heating Element #1 Sensors

J13 Socket - Heating Element #2 Sensors

J14 Socket - Heating Element #3 Sensors

J15 Socket - Heating Element #4 Sensors

J16 Socket - Heating Element #5 Sensors

J17 Wiring Terminals - Contactor Coils

TERMINAL	DESCRIPTION
OUT 4	120 VAC hot to Heating Element #4 Contactor Coil - if so equipped
OUT 5	120 VAC hot to Heating Element #5 Contactor Coil - if so equipped

CCB Enable/Disable Circuit(s) Test

The electronic control system includes two enable/disable circuits (see page 63) for use with field installed supervisory controls such as building EMS (Energy Management System). These two circuits are located at the CCB's four pin J7 Socket. Both of these Enable/Disable circuits must be closed to enable heating operation. If either circuit is open for any reason heating operation will be disabled even though the tank temperature may be well below the Operating Set Point - see Heating Cycle Disabled on page 75.

There is a plug with two jumper wires installed from the factory in the CCB J7 socket to enable heating operation when external controls are not in use. If the plug is not present or if one of the two jumper wires fails to close either enable/disable circuit heating operation will be disabled. A simple continuity check is performed on the J7 Plug end to ensure heating should not be disabled as follows:

- 1 If either enable/disable circuit is in use (external wiring connected to J7 plug) by an external supervisory control - ensure that control's dry contacts are closed to enable heating operation. Check the supervisory control's settings/programming to ensure it is not disabling heating operation during occupied/peak demand periods.
- 2 If the J7 plug is missing or jumper wires are not installed in the J7 plug - call the toll free Technical Support phone number listed on the back cover of this manual for further assistance
- 3 If there are no external supervisory controls wired to the J7 plug: Secure power to the water heater. Unplug the J7 plug from the CCB - see page 50 for location.
- 4 Using an ohm meter; set the Ohm meter to it's lowest resistance range (< 200) or to an audible beep continuity test setting if so equipped.
- 5 Touch the ohm meter probes between pins 1 & 2 first and then between pins 3 & 4 of the J7 plug end as shown in the images below. There should be continuity present in both tests.
 - If the ohm meter shows no continuity (open circuit) between pins 1 & 2 or between pins 3 & 4 of the J7 plug end ensure the two jumper wires are properly installed in the plug end and are not broken. Ensure the J7 plug/socket connection is mating properly and providing good contact. Repair/replace damaged plug connectors/wiring as necessary.
 - If the ohm meter shows continuity (closed circuit) between pins 1 & 2 and between pins 3 & 4 of the J7 plug end and heating operation will not activate with a cold tank of water call the toll free Technical Support phone number listed on the back cover of this manual for further assistance.

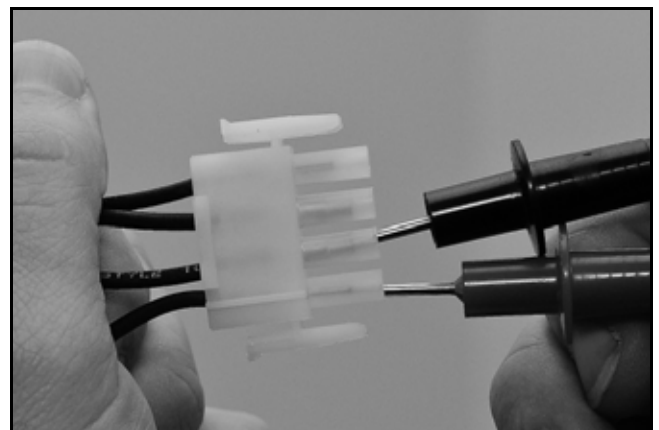
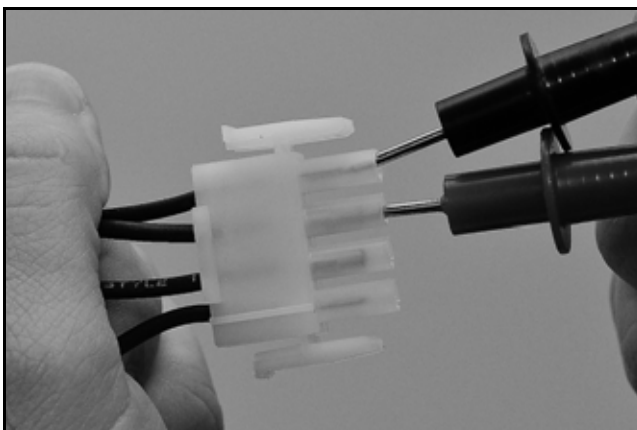

Service Note: If a supervisory control(s) is used to enable/disable heating operation, install field wiring between the J7 socket on the CCB and a set of “dry contacts” on the external control per all applicable building codes. This is a switching circuit only: **DO NOT** apply any external voltage or connect any load (IE: relay coil) to either circuit.

Checking Power and Ground To The CCB

The CCB is powered by the 120 VAC Control Circuit Transformer (see pages 39 - 41) at the J2 Socket, pins 1 & 3 (see page 50). This procedure is performed to ensure the 120 VAC power is being supplied to the CCB.

- 1 Ensure the main breaker or disconnect switch is turned on.
- 2 Verify with an AC volt meter that proper voltage is present at the Power Distribution Block or the contactor on single element models (see Figures 1 and 2 on pages 8 & 9 and pages 12 - 14).
- 3 Using an AC volt meter; set the volt meter to an AC voltage range just above 120 VAC.
- 4 **Ensure 120 VAC power is supplied to the CCB.** With the J2 plug installed in the J2 socket on the CCB (page 50) insert the two volt meter probes into pins 1 & 3 of J2 plug as shown in the "Checking for 120 VAC" image below. Volt meter probes may have to be pressed firmly into the plug to make contact with the metal conductors inside. Voltage should be approximately 120 VAC.
- 5 If the measured voltage is approximately 120 VAC the CCB is receiving the correct power.
- 6 If the measured voltage is zero volts or considerably less than 120 VAC:
 - Check the 120 VAC wiring between the CCB J2 socket and the 120 VAC Control Circuit Transformer - ensure wiring is correct and connections are tight and making good contact.
 - Check the J2 plug/socket connections on the CCB for wear or damage. Ensure they are mating properly and providing good contact - see page 50.
 - Check the 120 VAC Control Circuit Transformer to ensure it is wired correctly and outputting the correct voltage - see pages 39 - 41.
 - Check the Control Circuit fuses - see Figures 1 and 2 on pages 8 & 9 for location and the Fuse test procedure on page 15.
- 7 **Ensure earth ground is supplied to the CCB.** With the J2 plug installed in the J2 socket on the CCB (page 50) insert the two volt meter probes into pins 1 & 2 of the J2 plug as shown in the "Checking for Ground" image below. Volt meter probes may have to be pressed firmly into the plug to make contact with the metal conductors inside. If the measured voltage is approximately 120 VAC the CCB is properly grounded.
- 8 If the measured voltage is zero volts or considerably less than 120 VAC:
 - Check the ground wiring between the CCB J2 socket and the water heater's ground connection - ensure wiring is correct and connections are tight and making good contact.
 - Ensure the water heater is properly grounded.

Checking for 120 VAC



Checking for Ground

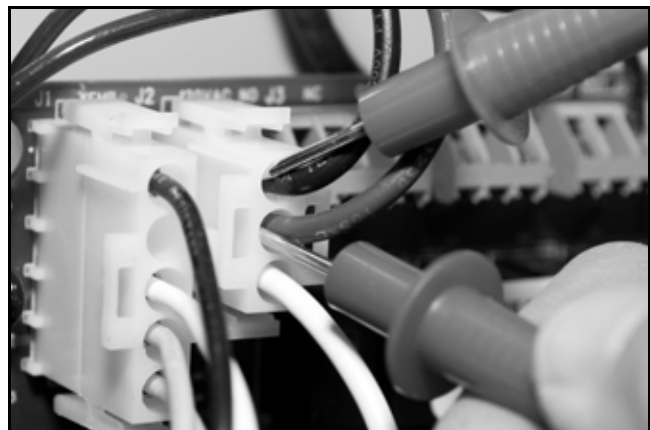

UIM - User Interface Module

The UIM's major components include a Circuit Board with LCD display and a Button Pad Overlay which contains the five user input buttons.

Service Note: The Ribbon Cable that connects the Button Pad Overlay to the UIM Circuit Board must be plugged in exactly as shown in the images below; with the metal crimp connections visible on the plug end and the UIM Circuit Board back facing out. There are six pins on this Ribbon cable socket, Ensure all six pins are inserted into the Ribbon Cable plug whenever removing or installing the UIM or Button Pad Overlay.

Failure to connect this Ribbon cable exactly as shown when servicing will render the User Input Buttons inoperable. This should be checked whenever the nature of the service complaint is an inoperable or unresponsive controller or UIM.

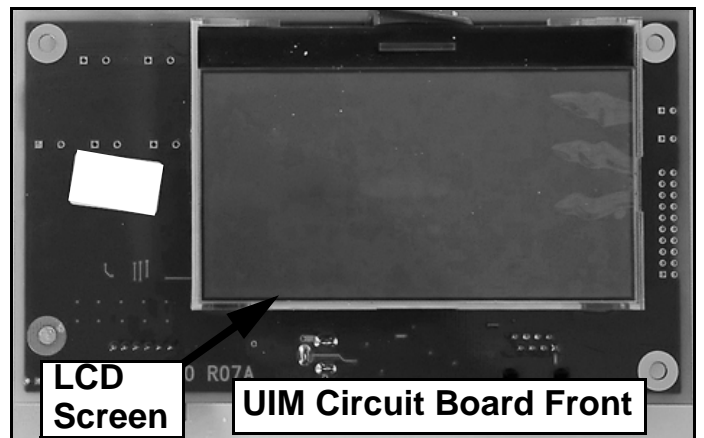
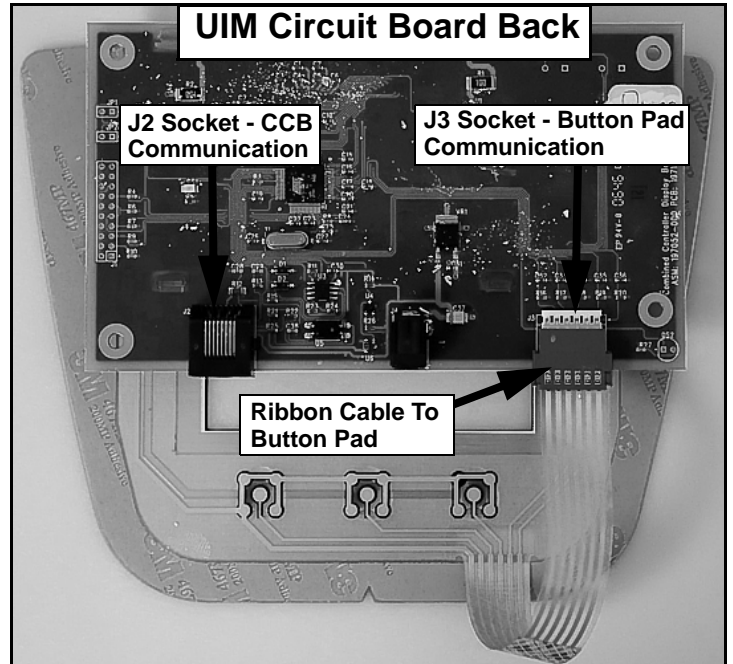
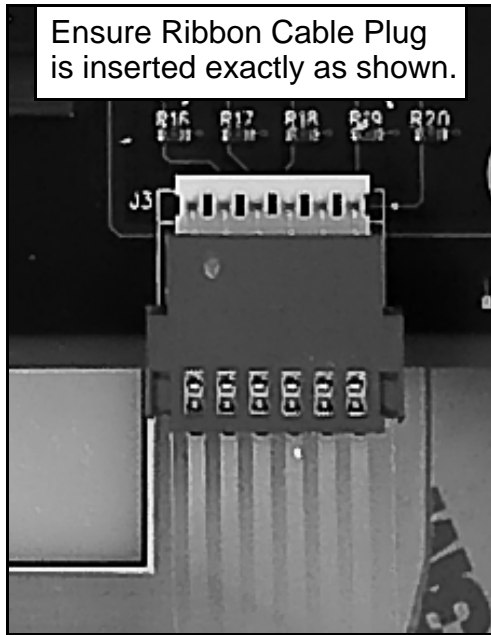
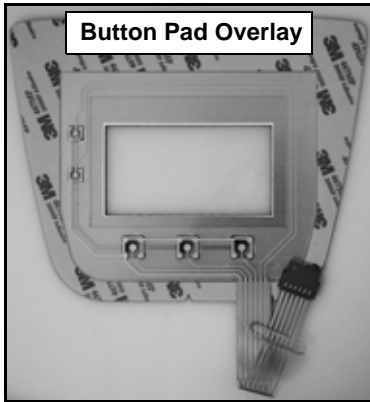

ELECTRONIC CONTROL SYSTEM

HEATING ELEMENT OPERATION

Depending on tank size and how they were ordered from the factory the water heaters covered in this manual may be equipped with 1 to 5 electric heating elements. See Heating Element Construction on page 16. The illustration here shows how the heating elements are numbered and initially cycled on by the control system - top to bottom. The illustration also shows how the openings for each heating element are physically arranged on a water heater equipped with 5 heating elements.

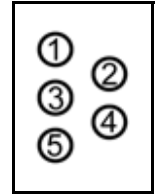

Control Options

The water heaters covered in this manual are factory ordered with 1 of 3 different heating element control options as follows:

Standard On/Off Control: This is the only configuration available on models equipped with a single heating element and the standard configuration on models equipped with more than one element. All elements are cycled on simultaneously with each call for heat, however there is a one second delay between elements being energized to reduce starting current. All elements are cycled off at the same time at the end of each heating cycle.

Optional Modulation Sequencing: Available on models equipped with more than one heating element. First On/First Off cycling of heating elements - the first heating element energized at the beginning of a heating cycle is the first element de-energized at the end of the heating cycle. Elements are energized and de-energized according to adjustable (1 to 20°F) Differential set points for each element - see page 61. Element Rotation - the first element energized is rotated with each successive heating cycle. Successive heating cycles would progress as follows on a model equipped with 3 heating elements:

- First heating cycle: Elements come on [1, 2, 3] and cycle off [1, 2, 3].
- Second heating cycle: Elements come on [2, 3, 1] and cycle off [2, 3, 1].
- Third heating cycle: Elements come on: [3, 1, 2] and cycle off [3, 1, 2].
- Fourth heating cycle: pattern repeats - same as first.

Optional Linear Sequencing: Available on models equipped with more than one heating element. Operation is the same as Modulation Sequencing described above except that the “First” heating element energized will be the “Last” element de-energized during operation. IE: First On/Last Off cycling of heating elements. Successive heating cycles would progress as follows on a model equipped with 3 heating elements:

- First heating cycle: Elements come on [1, 2, 3] and cycle off [3, 2, 1].
- Second heating cycle: Elements come on [2, 3, 1] and cycle off [1, 3, 2].
- Third heating cycle: Elements come on: [3, 1, 2] and cycle off [2, 1, 3].
- Fourth heating cycle: pattern repeats - same as first.

CONTROL SYSTEM FEATURES

Advanced Diagnostics

Plain English text and animated icons display detailed operational and diagnostic information. LCD screen on the front of the water heater displays the Sequence of Operation in real time. Fault or Alert messages are displayed when operational problems occur - see pages 76 - 80. An Advanced Service menu displays a list of possible causes for current Fault and Alert conditions to aid in servicing.

Economy Mode Operation

The control system automatically lowers the Operating Set Point by a programmed value during user defined time periods. Helps reduce operating costs during unoccupied or peak demand periods. See Economy Mode Setup Menu on pages 64 - 67.

CONTROL SYSTEM NAVIGATION

The UIM (User Interface Module) is located on the front cabinet of the water heater. All operational information and user settings are displayed and accessed using the UIM. The UIM includes five snap acting (momentary) user input buttons; an Up, Down and 3 Operational Buttons.

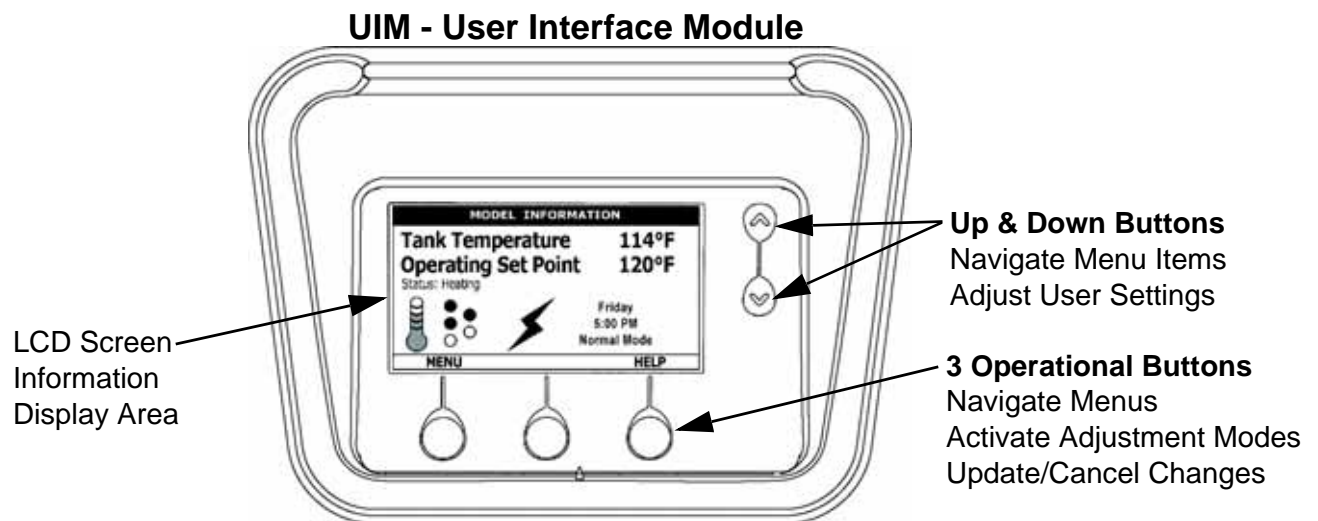

Figure 6

Up & Down Buttons

Used to navigate (up and down) and to select (highlight) menu items. Also used to adjust or change (increase/decrease, on/off, set time) various user settings.

Operational Buttons

The 3 Operational Buttons are multifunctional. Their current function is defined by the text that appears directly above each button on the LCD screen. The function will change depending on what menu is currently displayed or what menu item is selected. When no text appears on the LCD screen above an Operational Button there is no function assigned.

THE DESKTOP SCREEN

The illustration below shows the control system “Desktop Screen.” This is the default screen. If there are no active Fault or Alert conditions and no user input for approximately 10 minutes the control system will return to this screen automatically.

Model Information: Model information and menu titles are shown in the black bar at the top of the Desktop Screen.

Tank Temperature: Current water temperature as sensed from the immersion Temperature Probe - see page 43.

Operating Set Point: Temperature at which the control system will maintain tank (water) temperature in the Normal Mode. This line of text will read **Economy Set Point** whenever the control system is operating in the Economy Mode. See Temperatures Menu on page 61 and Economy Mode Setup Menu on pages 64 - 67.

Status: The Operating State of the control system is displayed beneath the Operating Set Point. See Table 2 on page 60.

Service Note: The Desktop Screen displays text and animated icons that convey operational information.

Review the Status Icons explanation in Table 1 on page 59. Learning to use this real time visual display of the operating sequence will help to quickly and accurately diagnose operational problems.

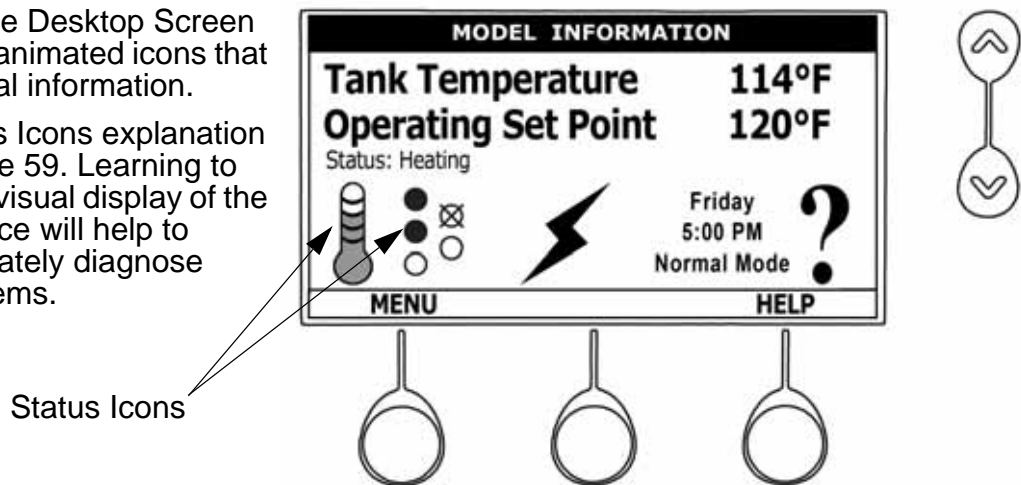

Figure 7

Day/Time/Operating Mode: The current time and day are also displayed on the Desktop Screen. “Clock Not Set” will be displayed until the time clock has been initially set. Day and Time are adjusted in the Economy Mode Setup menu - see page 66. The current Operating Mode, either Normal Mode or Economy Mode, is displayed beneath the day and time.













Menu: The left Operational Button is pressed to enter the Main Menu where all control system menus are accessed. See Table 3 on page 60 for a list of control system menus.

Help: The right Operational Button is pressed to access instructions and explanations for user settings, Operating States, Status Icons, manufacturer’s web address, technical support phone number and service agent contact information.

Discreet Menu Contact Information: From the Desktop Screen press and hold down the middle (unmarked) Operational Button for 30 seconds and then release it. This will launch a discreet menu where personalized contact information can be entered. Installing contractors and/or service agents can enter their company name and telephone number. This contact information will be displayed with all Fault and Alert messages.

ELECTRONIC CONTROL SYSTEM

Table 1 Status Icons

ICON	DESCRIPTION
	Water temperature in the tank has fallen. Shaded area of the animated thermometer icon will rise and fall in response to water temperature in the storage tank as sensed from the immersion Temperature Probe.
	Water temperature in the tank has reached the Operating Set Point. Shaded area of the animated thermometer icon will rise and fall in response to water temperature in the storage tank as sensed from the immersion Temperature Probe.
	The control is unable to initiate a heating cycle. This will happen whenever a Fault condition is detected by the control system or when either of the two Enable/Disable circuits are open circuits. For more information on Enable/Disable circuits review the Heater Status Menu information on page 63.
	The control system is in Heating Mode and has energized the electromagnetic contactor coils for at least one heating element. This animated icon DOES NOT indicate current has been sensed from the heating elements, only that there is a call for heat present and the control system has initiated heating element operation.
	Heating element icon for a water heater equipped with 1 heating element. Open circles represent elements the control system has not energized and IS NOT sensing electrical current flow from.
	Heating element icon for a water heater equipped with 2 heating elements. Each circle represents one element. Open circles represent elements the control system has not energized and IS NOT sensing electrical current flow from. Filled circles represent elements the control system has energized and IS sensing electrical current flow from.
	Heating element icon for a water heater equipped with 3 heating elements. Each circle represents one element. Filled circles represent elements the control system has energized and IS sensing electrical current flow from.
	Heating element icon for a water heater equipped with 4 heating elements. Each circle represents one element. Open circles with an X represent elements the control system has energized that it IS NOT sensing electrical current flow from.
	Heating element icon for a water heater equipped with 5 heating elements. Each circle represents one element. Open circles represent elements the control system has not energized and IS NOT sensing electrical current flow from. Filled circles represent elements the control system has energized and IS sensing electrical current flow from.
	Heating element icon for a water heater equipped with 5 heating elements. In this example 4 elements have been energized and 1 element has not. The control system IS sensing electrical current flow from 2 elements. The control system IS NOT sensing electrical current flow from 2 elements that it should. The control system would declare an Alert Condition in this case but would continue to operate.
	The control has detected/declared a Fault Condition. Fault message details can be viewed in the Current Fault menu. Heating operation is discontinued (locked out) until the condition that caused the Fault is corrected. Power to the water heater must be cycled off and on to reset the control system. Note; cycling power will not reset the control system if the condition that caused the Fault has not been corrected.
	The control has detected/declared an Alert Condition. The water heater will continue to operate during an Alert Condition but there is an operational condition that requires the attention of a Qualified Service Agent. Alert message details can be viewed in the Current Alert menu.

ELECTRONIC CONTROL SYSTEM

Table 2 - Operating States

STATE	DESCRIPTION
Standby	The water heater is not in an active heating cycle. This usually indicates the temperature in the tank has reached the Operating Set Point and the control system has terminated the heating cycle.
Heating	The control system is in the Heating Mode. At least one heating element has been energized.
Alert	The control system has detected/declared an Alert Condition. The controls system will continue heating operation. However, a Qualified Service Agent should be contacted to check/service the water heater.
Fault	The control system has detected/declared a Fault Condition. The control system will discontinue heating operation and "lock out." Power to the water heater must be cycled off and on to reset the control system. Note; cycling power will not reset the control system until the condition that caused the Fault has been corrected.

Table 3 - Control System Menus

MENUS†	DESCRIPTION
Temperatures	Most commonly accessed menu. Operating Set Point, Differential settings, Tank Temperature and Tank Probe Offset are located in this menu.
Heater Status	Current Operating State/Mode (heating/standby etc) and status (open/closed - on/off - yes/no) of monitored water heater functions and components are displayed in this menu.
Economy Mode Setup	Seven day 24 hour time clock with temperature set back capability to reduce operating costs during unoccupied or reduced demand periods.
Alarm Output Setup	The control system's CCB (Central Control Board - see page 50) features on board SPDT (single pole double throw) relay contacts for building EMS (Energy Management System) notification of operational conditions such as Fault Conditions and heating mode status. This menu features a list of user definable conditions for relay activation.
Display Settings	Temperature units (°F or °C), appearance (brightness contrast) and backlight delay user adjustable settings are located in this menu.
Heater Information	Elapsed time of operation, total heating cycle time, heating cycle count, heating element(s) cycle count and on time along with UIM and CCB software revisions can be viewed in this menu.
Current Fault/Alert	Displays any current Alert or Fault messages.
Fault History	Retains 9 event history of Fault/Alert messages with time stamp. The Fault History is useful when dealing with intermittent operational problems or when the customer has reset the control system prior to a service agent's arrival.
Fault Occurrence	Total accumulated number each individual Fault condition has occurred is displayed in this menu. This running total of Fault Occurrences can be useful in determining which (if any) operational problems have been persistent.
Restore Factory Defaults	This control system feature allows the user to restore control system user settings to their factory default settings. Alarm Output Setup and Display Settings menu items ARE NOT changed when factory defaults are restored.
Help Menu	Accessible by pressing the corresponding Operational Button from most menus and screen displays. This menu provides access to instructions and explanations for user settings, Operating States, Status Icons, manufacturer's web address, technical support phone number and service agent contact information.

†. This table shows a list of the control system menus. These menus will be explained in greater detail in the pages that follow.

TEMPERATURES MENU

Operating Set Point

User adjustable setting 90°F to 190°F range; factory default is 120°F. When the water temperature sensed by the control system from the immersion Temperature Probe reaches the Operating Set Point the control system will end the heating cycle. A call for heat will be activated again when the water temperature drops below the Operating Set Point minus the 1st Differential Setting.

Temperatures	
Operating Set Point	120°F
1st Differential	2°F
2nd Differential	2°F
3rd Differential	2°F
Tank Temperature	105°F
Tank Probe Offset	0°F
CHANGE	BACK HELP

Example: Operating Set Point is 120°F, the 1st Differential Setting is 2°F (factory default). A call for heat will be activated when the sensed water temperature drops to 118°F.

Differential Settings

Adjustable user setting(s) 1°F to 20° range; factory default is 2°F. The water heaters covered in this manual will have between 1 and 5 heating elements. There is at least one Differential Setting on all models. There will be additional Differential Settings for each additional heating element installed.

Operating Sequence: On a water heater equipped with 3 heating elements, with an Operating Set Point of 120°F and all Differential settings at 2°F the On/Off sequencing of heating elements would be as follows:

ELEMENT NUMBER	DIFFERENTIAL SETTING	TURN ON TEMP	TURN OFF TEMP
Element 1	2°F	118°F	120°F
Element 2	2°F	116°F	118°F
Element 3	2°F	114°F	116°F

Tank Temperature

Non adjustable information display. Current water temperature as sensed by the control system from the immersion Temperature Probe.

Tank Probe Offset

User adjustable setting -5°F to +5°F range; factory default is 0°F. If the current Tank Temperature is sensed (from the immersion Temperature Probe) at 120°F and the offset is adjusted to -5°F the control system would calibrate or “offset” the Tank Temperature to 115°F. Heating cycles would then start/stop based on the calibrated Tank Temperature.

Used to calibrate for slight differences in control system temperature sensing. This can improve the precision of temperature control in the storage tank and at points of use. This feature can also be used to compensate for building recirculation loops (hot water returning to the storage tank) that may cause the heating cycle to terminate prematurely.

Temperature Settings

The Operating Set Point and the Differential Settings are adjusted in the Temperatures Menu. The following instructions explain how to adjust these user settings and navigate the control system menus.

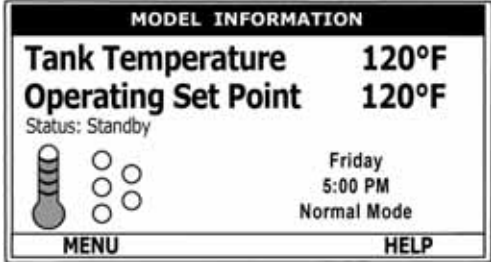
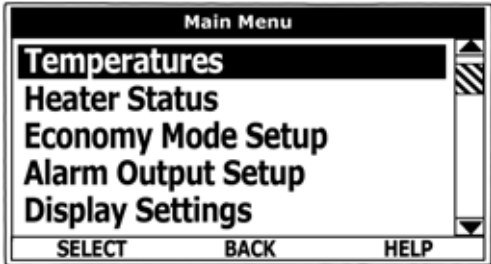
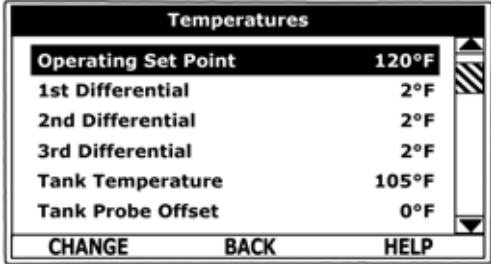
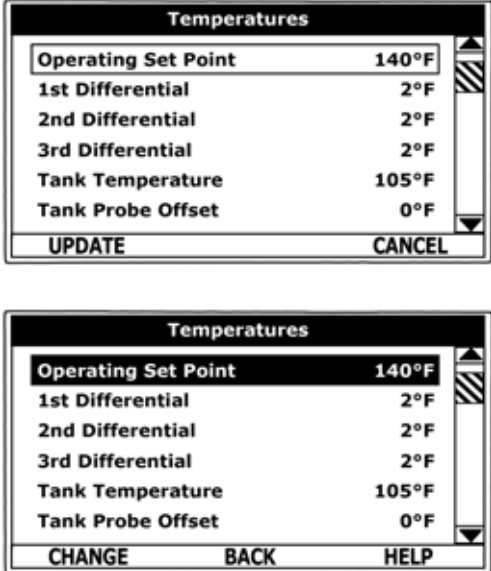
ACTION	DISPLAY
<p>From the Desktop Screen, press the Operational Button underneath "MENU" to enter the Main Menu.</p> <p>(see UIM Navigation on page 57)</p> <p>Notice how the text above the Operational Buttons on the display changes as you navigate through the various menus and screens.</p>	
<p>With Temperatures selected (highlight in black) in the Main Menu, press the Operational Button underneath "SELECT" to enter the Temperatures Menu.</p> <p>If Temperatures is not selected use the Up and Down buttons to select this menu item.</p>	
<p>With the Operating Set Point selected (highlight in black) in the Temperatures Menu, press the Operational Button underneath "CHANGE" to activate the adjustment mode for this menu item.</p>	
<p>Press the Up and Down buttons to adjust the Operating Set Point to the desired setting.</p> <p>Press the Operational Button underneath "UPDATE" to confirm the new setting. Press the Operational Button underneath "CANCEL" to discard the new setting and retain the previous setting.</p> <p>The new Operating Set Point value should now be displayed as the current value.</p> <p>NOTE: Use this same procedure to adjust the Differential settings and the Tank Probe Offset in the Temperatures Menu.</p> <p>This same procedure is used to change user settings in other control system menus.</p>	

HEATER STATUS MENU

This menu displays non adjustable operational information. Use the Up & Down Buttons to navigate to the bottom and top of this menu.

Status

Displays the current Operating State of the control system. IE: Heating, Standby, Fault.

Elements On

Displays the number of heating elements the control system has energized.

ECO Contact

Displays the current state of the ECO high temperature limit switch contacts.

Enable / Disable 1 & 2

Displays the current state, open or closed, of the two Enable/Disable circuits (J7 socket on the CCB - see page 52) provided for external supervisory controls such as building EMS (Energy Management System). Both of these Enable/Disable circuits must be closed to “enable” heating operation. If either circuit is open heating will be “disabled.” A plug with two jumper wires is installed from the factory in the CCB J7 socket to enable heating operation when external controls are not in use.

Service Note: If a supervisory control(s) is used to enable/disable heating operation, install field wiring between the J7 socket on the CCB and a set of “dry contacts” on the external control per all applicable building codes. This is a switching circuit only: **DO NOT** apply any external voltage or connect any load (IE: relay coil) to either circuit.

Element # On

Displays the on/off status of each heating element. Yes = On, No = Off.

Tank Full

Displays the status of the LWCO (Low Water Cut Off) device. Yes = water level is at or above the LWCO probe, No = water level is low - see page 47.

Alarm Condition

Displays the status of the user definable Alarm Output function (see page 68). Yes = alarm condition has been met, No = alarm condition has not been met.

Alarm Relay Output

Displays the state of the normally open contacts of the Alarm Output relay. This relay (J3 contacts on the CCB - see page 50) is used for building EMS (Energy Management System) notification of operational conditions such as Fault conditions and heating mode status.

Top Of Menu

Heater Status	
Status	Heating
Elements On	1
ECO Contact	Closed
Enable / Disable 1	Closed
Enable / Disable 2	Closed
Element 1 On	Yes
Element 2 On	No
BACK HELP	

Bottom Of Menu

Heater Status	
Enable / Disable 2	Closed
Element 1 On	Yes
Element 2 On	No
Element 3 On	No
Tank Full	Yes
Alarm Condition	No
Alarm Relay Output	Open
BACK HELP	

ECONOMY MODE SETUP MENU

This menu contains settings used to establish an “Economy Set Point” and “Economy Mode” operating periods. This control system feature can help reduce operating costs during unoccupied or low demand periods.

Setpoint Adjustment

Adjustable user setting (2°F to 50°F - factory default is 20°F) the control system uses to calculate the “Economy Set Point.” The Economy Set Point = normal Operating Set Point minus the programmed Setpoint Adjustment value. The Economy Set Point is the water temperature the control system maintains during programmed Economy Mode time periods. “Economy Set Point” is displayed instead of “Operating Set Point” and “Economy Mode” appears beneath the current time on the Desktop Screen during Economy Mode time periods.

Current Time

Seven Day 24 hr clock. Use this menu item to set the current time and day of the week. Current day and time are not set from the factory. “Clock Not Set” will be displayed on the Desktop until the time/day has been initially set. Note: the time will not self adjust for Daylight Savings time.

Heater In Economy Mode

Displays whether the control system is currently operating in Economy Mode or not.

Daily Operating Mode (Sun - Mon - Tue - Wed - Thu - Fri - Sat)

Seven daily sub menus are listed at the bottom of the Economy Mode Setup menu. There are 3 Operating Modes available in each daily sub menu; “Normal Operation All Day” - “Economy Mode All Day” and “Normal Operation Between.” Only one Operating Mode can be active at a time, the factory default is Normal Operation All Day.

Normal Operation All Day: When this operating mode is active the normal Operating Set Point (Temperatures Menu - page 61) is used for the entire day.

Economy Mode All Day: When this operating mode is active the Economy Set Point is used for the entire day. Economy Set Point = normal Operating Set Point minus the programmed Setpoint Adjustment value.

Normal Operation Between: When this operating mode is active there will also be start and stop times to program. The normal Operating Set Point is used between the programmed start and stop times and the Economy Set Point will be in effect during the rest of the day. There is one programmable start and stop time event per day.

Desktop Screen During Economy Mode

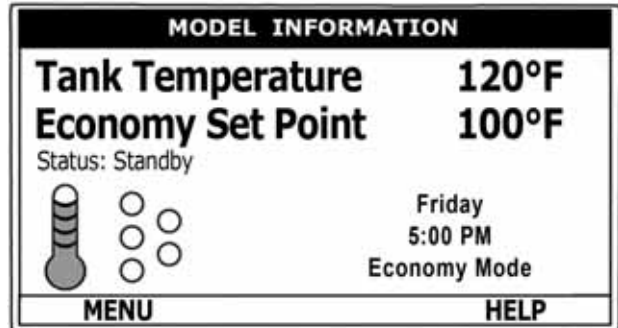

Economy Mode Setup Menu

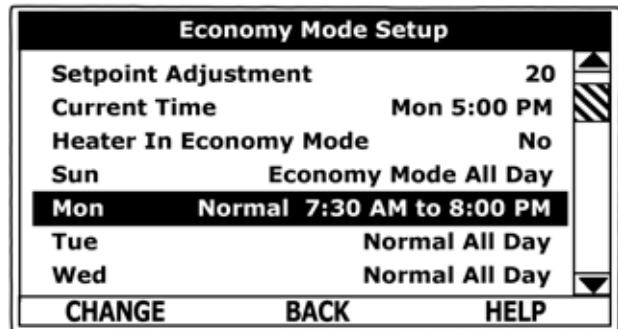

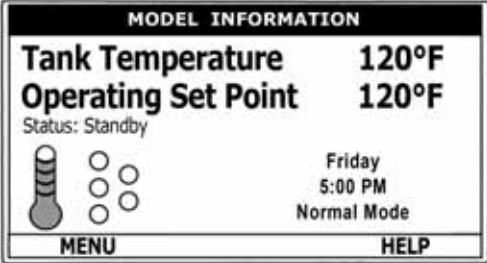
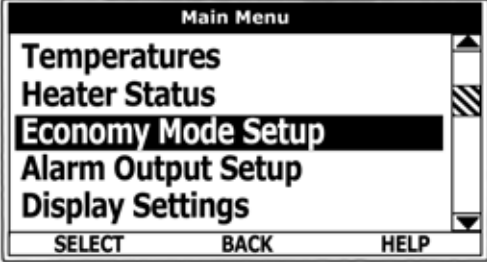
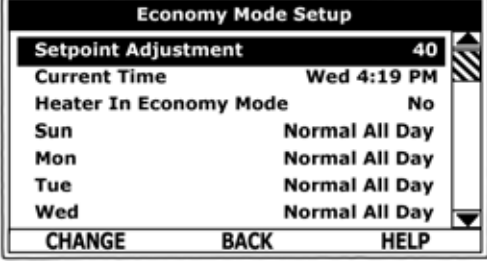
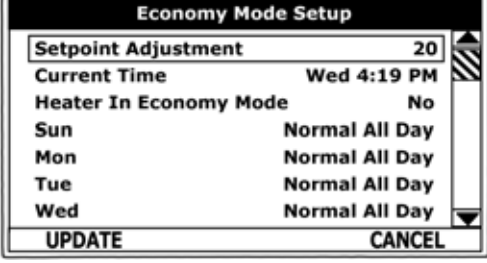
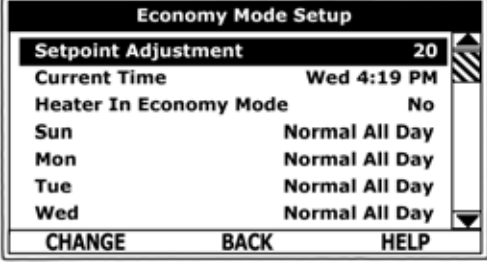

Economy Mode Settings

Setpoint Adjustment Value

ACTION	DISPLAY
<p>From the Desktop screen, press the Operational Button underneath "MENU" to enter the Main Menu. (see UIM Navigation on page 57)</p> <p>Notice how the text above the Operational Buttons on the display changes as you navigate through the various menus and screens.</p>	
<p>Use the Up/Down buttons to select (highlight in black) the Economy Mode Setup menu from the Main Menu. Press the Operational Button underneath "SELECT" to enter the Economy Mode Setup menu.</p>	
<p>Use the Up/Down buttons to select (highlight in black) Setpoint Adjustment. Press the Operational Button underneath "CHANGE" to activate the adjustment mode for the Setpoint Adjustment value.</p>	
<p>Use the Up/Down buttons to change the Setpoint Adjustment to the desired value. The Setpoint Adjustment value is adjustable from 2°F to 50°F. The factory default is 20°F.</p> <p>Notice how the text above the Operational Buttons on the display changes to "UPDATE" & "CANCEL" when the adjustment mode is activated and how the current value is outlined rather than highlighted in black.</p> <p>Press the Operational Button underneath "UPDATE" to enter and confirm the new value. Pressing the Operational Button underneath "CANCEL" would discard the new value and retain the previous value.</p>	
<p>The new Setpoint Adjustment value should now be displayed as the current value.</p>	

Economy Mode Settings

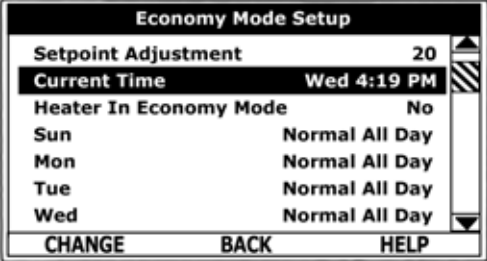
Time Clock Settings

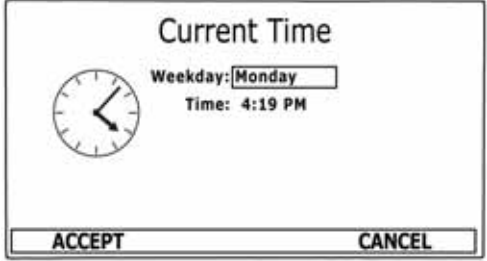
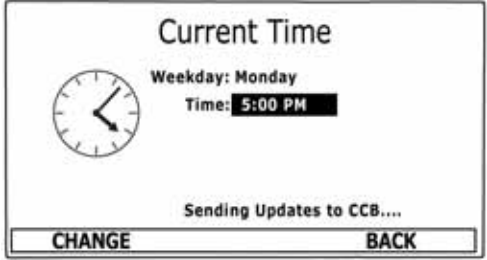
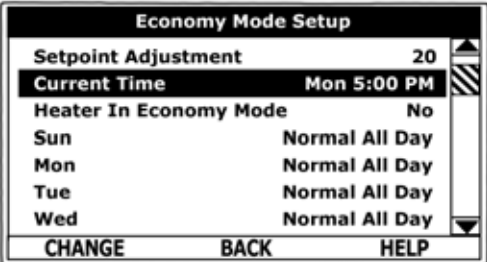
ACTION	DISPLAY
<p>From the Desktop Screen navigate to the Economy Mode Setup menu - see page 65 for instructions.</p> <p>Use the Up/Down buttons to select (highlight in black) Current Time sub menu. Press the Operational Button underneath "CHANGE" to enter the Current Time sub menu.</p>	 <p>The screenshot shows the 'Economy Mode Setup' menu. The 'Current Time' option is highlighted in black. Below it, the heater mode is set to 'No', and the days of the week (Sun, Mon, Tue, Wed) are all set to 'Normal All Day'. At the bottom, there are three buttons: 'CHANGE', 'BACK', and 'HELP'.</p>
<p>Use the Up/Down buttons to select the "Weekday" setting.</p> <p>Press the Operational Button underneath "CHANGE" to activate the adjustment mode for this setting.</p>	 <p>The screenshot shows the 'Current Time' adjustment screen. It features a clock icon on the left. The text indicates 'Weekday: Wednesday' and 'Time: 4:19 PM'. At the bottom, there are two buttons: 'CHANGE' and 'BACK'.</p>
<p>Press the Up and Down buttons to adjust the Weekday setting to the current day.</p> <p>Notice how the text above the Operational Buttons on the display changes to "ACCEPT" & "CANCEL" when the adjustment mode is activated and how the current setting is outlined rather than highlighted in black.</p> <p>Press the Operational Button underneath "ACCEPT" to enter and confirm the new setting. Pressing the Operational Button underneath "CANCEL" would discard the new setting and retain the previous setting.</p>	 <p>The screenshot shows the 'Current Time' adjustment screen. The 'Weekday' is now set to 'Monday' and is outlined in a box. The time remains '4:19 PM'. At the bottom, the buttons are now 'ACCEPT' and 'CANCEL'.</p>
<p>Use the Up/Down and the CHANGE/ACCEPT Operational Buttons to individually select and change the remaining time settings (Hour, Minutes, AM/PM) to the current time in the same way as outlined above.</p> <p>When finished making changes press the Operational Button underneath "BACK" to confirm all new settings and update the control system. The display will automatically return to the Economy Mode Setup menu.</p>	 <p>The screenshot shows the 'Current Time' adjustment screen. The time is now set to '5:00 PM'. A status message at the bottom reads 'Sending Updates to CCB....'. At the bottom, there are two buttons: 'CHANGE' and 'BACK'.</p>
<p>The new settings should be displayed as the Current Time.</p>	 <p>The screenshot shows the 'Economy Mode Setup' menu. The 'Current Time' option is highlighted in black, and the time is now 'Mon 5:00 PM'. The other settings remain the same as in the first screenshot. At the bottom, there are three buttons: 'CHANGE', 'BACK', and 'HELP'.</p>

Economy Mode Settings

Daily Operating Mode Settings

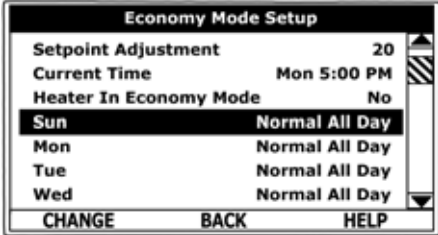
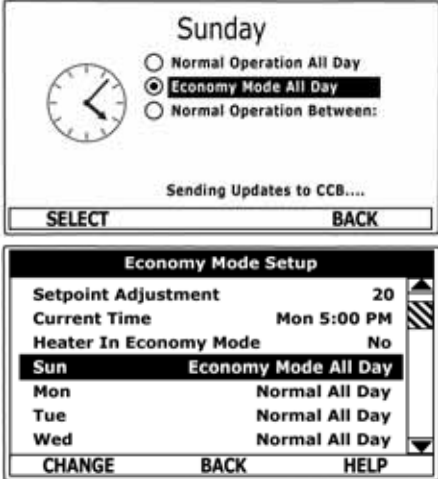
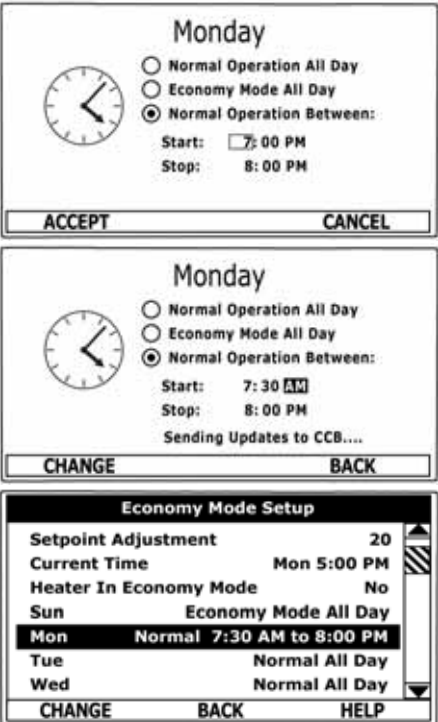
ACTION	DISPLAY
<p><u>Economy Mode All Day:</u></p> <p>From the Economy Mode Setup menu use the Up/Down buttons to select (highlight in black) the Daily sub menu for “Sun.” Press the Operational Button underneath “CHANGE” to enter this menu.</p> <p>See “Time Clock” settings on page 66 for instructions on navigating to the Economy Mode Setup menu.</p>	 <p>The screenshot shows the 'Economy Mode Setup' menu. At the top, it displays 'Setpoint Adjustment 20', 'Current Time Mon 5:00 PM', and 'Heater In Economy Mode No'. Below this, a list of days is shown: Sun, Mon, Tue, and Wed. The 'Sun' row is highlighted in black and shows 'Normal All Day'. At the bottom, there are three buttons: 'CHANGE', 'BACK', and 'HELP'.</p>
<p>Use the Up/Down buttons to select (highlight in black) the “Economy Mode All Day” setting.</p> <p>Press the Operational Button underneath “SELECT” to change from the factory default Normal Operation All Day setting to the Economy Mode All Day setting.</p> <p>Press the Operational Button underneath “BACK” to confirm the new setting and update the control system. You will be returned to the Economy Mode Setup menu. The new setting should now be displayed for Sun.</p>	 <p>The first screenshot shows the 'Sunday' selection screen. It features a clock icon and three radio button options: 'Normal Operation All Day', 'Economy Mode All Day' (which is selected), and 'Normal Operation Between:'. Below the options, it says 'Sending Updates to CCB...'. At the bottom are 'SELECT' and 'BACK' buttons.</p> <p>The second screenshot shows the 'Economy Mode Setup' menu again, but now the 'Sun' row is highlighted in black and shows 'Economy Mode All Day'. The other days (Mon, Tue, Wed) remain 'Normal All Day'. The 'CHANGE', 'BACK', and 'HELP' buttons are still at the bottom.</p>
<p><u>Normal Operation Between:</u></p> <p>From the Economy Mode Setup menu Use the Up/Down and CHANGE buttons to enter the Mon sub menu as described above.</p> <p>Use the Up/Down buttons to select (highlight in black) the “Normal Operation Between” setting. Press the Operational Button underneath “SELECT” to change the operating mode for Monday to Normal Operation Between. Note that when this setting is selected Start and Stop time user settings appear on the display.</p> <p>Use the Up/Down buttons to navigate between the Start and Stop time Hour, Minutes and AM/PM settings.</p> <p>With each item selected press the Operational Button underneath “CHANGE” to activate the adjustment mode for each setting. Use the Up/Down buttons to change the value to the desired setting.</p> <p>Press the Operational Button underneath “ACCEPT” to enter the new setting or “CANCEL” to discard the new setting and retain the previous setting.</p> <p>Press the Operational Button underneath “BACK” when finished to confirm the new settings and update the control system. The display will return to the Economy Mode Setup menu with the new settings shown for Mon.</p>	 <p>The first screenshot shows the 'Monday' selection screen. It features a clock icon and three radio button options: 'Normal Operation All Day', 'Economy Mode All Day', and 'Normal Operation Between:'. The 'Normal Operation Between:' option is selected. Below it, 'Start: 7:00 PM' and 'Stop: 8:00 PM' are displayed. At the bottom are 'ACCEPT' and 'CANCEL' buttons.</p> <p>The second screenshot shows the 'Monday' selection screen again, but now the 'Normal Operation Between:' option is selected, and the 'Start' time is set to '7:30 AM'. Below it, 'Stop: 8:00 PM' is displayed. It also says 'Sending Updates to CCB...'. At the bottom are 'CHANGE' and 'BACK' buttons.</p> <p>The third screenshot shows the 'Economy Mode Setup' menu. The 'Mon' row is highlighted in black and shows 'Normal 7:30 AM to 8:00 PM'. The other days (Sun, Tue, Wed) are 'Normal All Day'. The 'CHANGE', 'BACK', and 'HELP' buttons are at the bottom.</p>

ALARM OUTPUT SETUP MENU

Permits user to set the condition (from a list of options) for when the CCB's integral alarm output relay will be energized. Alarm relay connections (common, normally open, normally closed) are located on the J3 terminal strip on the CCB (see page 50). Alarm output relay contacts are capable of switching **1 amp maximum at 120 VAC.**

The alarm relay operates in the background according to the settings in this menu and is not capable of disabling water heater operation. The alarm relay is used for external notification/verification of various operational conditions such as Fault conditions and heating mode status. This relay can be used with building EMS (Energy Management System) and other external supervisory controls.

Output Function

Adjustable user setting. Available options for the Alarm Output Function setting are:

Heating Mode: Used for heating mode on/off status notification.

Enable / Disable Closed: Used for notification or verification of the enable/disable circuits open/closed status. There are two enable/disable circuits available for external supervisory control(s) at the J7 socket on the CCB - see page 50. Enable/disable circuit(s) status can be viewed in the Heater Status Menu - see page 63.

Temp < Heater SP: Used for external notification when current tank temperature drops below Operating Set Point.

Temp < Alarm SP: Used for external notification when current tank temperature drops below the programmable Alarm SP.

Fault or Alert: Used for external notification whenever a Fault or Alert condition is active.

Fault: Used for notification whenever a Fault condition is active.

Disabled: Disables the Alarm Relay Output Function - this is the factory default setting.

Alarm SP - (Alarm Set Point)

Adjustable user setting (90°F to 190°F) the control system uses for the "Temp < Alarm SP" function described above. This setting has no effect with any other Alarm Output functions.

Alarm Output Settings

Changing the user settings in this menu is done using the same method outlined in Temperature Settings on page 62.

Service Note: Adjustable user settings in the Alarm Output Setup menu are unaffected by Restore Factory Defaults (see page 72).

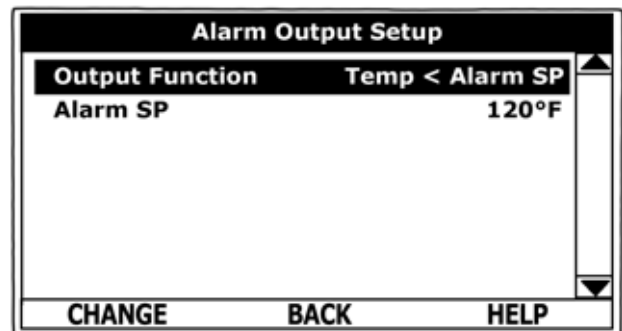
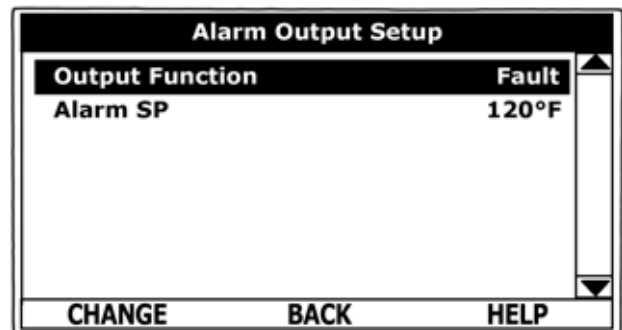

DISPLAY SETTINGS MENU

Permits user to set display options for viewing information on the UIM's LCD screen.

Temperature Units

Adjustable user setting that changes temperature units display to Celsius °C or Fahrenheit °F.

Backlight Delay

Adjustable user setting that determines how long the UIM's LCD backlight remains illuminated after a key has been pressed. Available settings are; Always Off, 10, 30 or 60 seconds and Always On.

Contrast

Adjustable user setting to adjust the UIM's LCD screen contrast between text and background.

Display Settings

Changing the user settings in this menu is done using the same methods outlined in Temperature Settings on page 62.

Service Note: Adjustable user settings in the Display Settings menu are unaffected by Restore Factory Defaults (see page 72).

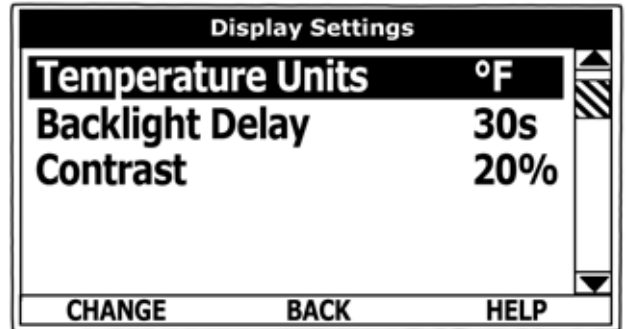

HEATER INFORMATION MENU

This menu displays non adjustable operational information.

Elapsed Time

Total accumulated time the control system (water heater) has been energized.

Total Heating Time

Total accumulated time the control system has been in the heating mode. IE: any heating element(s) has been energized.

Element # Cycles

Total accumulated count of heating cycles for each heating element.

Element # On Time

Total accumulated heating on time for each heating element.

CCB Version

Software version for Central Control Board - see page 50.

UIM Version

Software version for User Interface Module - see page 55.

Top Of Menu

Heater Information	
Elapsed Time	7 days 18 hrs 35 mins
Total Heating Time	2 days 46 mins
Cycle Count	00000042
Element 1 Cycles	00000035
Element 1 On Time	
BACK HELP	

Bottom Of Menu

Heater Information	
Element 2 On Time	1 day 4 hrs 44 mins
Element 3 Cycles	00000025
Element 3 On Time	8 hrs 30 mins
CCB Version	0.00
UIM Version	0.00
BACK HELP	

CURRENT FAULT / ALERT MENU

This menu displays non adjustable operational information. With the Fault History sub menu selected in Main Menu; press the Operational Button underneath "SELECT" to display the current Fault or Alert message. If there is not a Fault or Alert condition currently active "(none)" is displayed to the right of this menu.

FAULT HISTORY MENU

This menu displays non adjustable operational information. The control system records and stores the last 9 Fault and Alert messages in chronological order in this menu. The most recent will be at the top of the list. A time stamp is displayed below each listed Fault and Alert message showing when the Fault or Alert condition occurred.

The Fault History is useful when dealing with intermittent operational problems or when the customer has reset the control system prior to a service agent's arrival.

With a Fault or Alert item selected press the Operational Button underneath "VIEW" to display the details for the Fault or Alert message. The Fault/Alert message screen displays a brief description of the condition, contact information and access to the Advanced Service information sub menu.

FAULT OCCURRENCE MENU

Total accumulated number each individual Fault condition has occurred is displayed in this menu. This running total of Fault Occurrences can be useful in determining which (if any) operational problems have been persistent.

Main Menu - Current Fault Selected

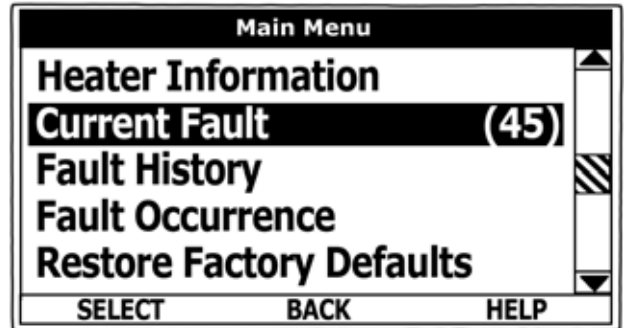

Fault History Menu

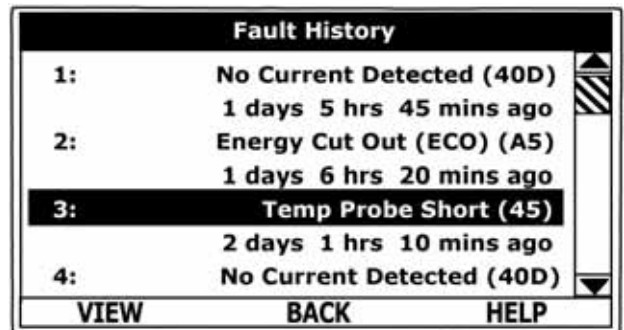

Current / History Fault Message



Fault Occurrence Menu

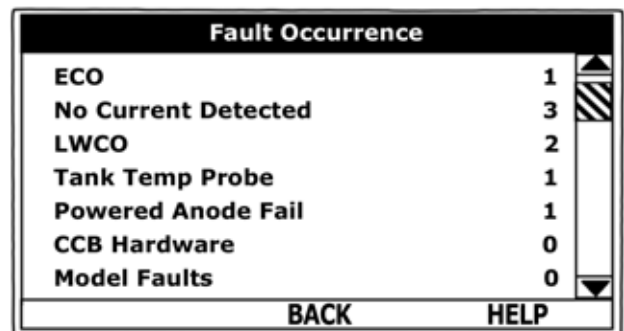

RESTORE FACTORY DEFAULTS MENU

This control system menu allows the user to restore most of the control system's user settings to their factory default settings. **User settings in the Alarm Output Setup and Display Settings menus are unaffected by executing Restore Factory Defaults.**

Restore Factory Defaults

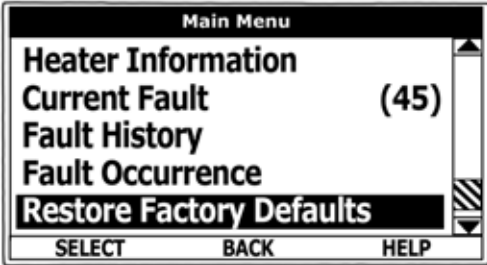
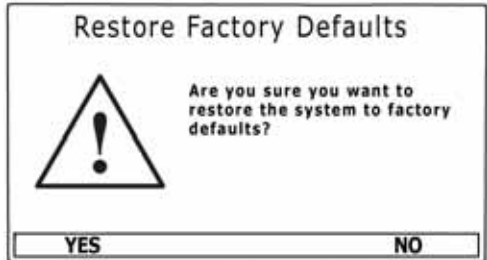
ACTION	DISPLAY
<p>From the Main Menu use the Up/Down buttons to select (highlight in black) the "Restore Factory Defaults" menu.</p> <p>Press the Operational Button underneath "SELECT." The Restore Factory Defaults menu will be displayed.</p>	
<p>From the Restore Factory Defaults menu press the Operational Button underneath "YES." The display will show text confirming the factory default settings have been restored.</p> <p>Press the Operational Button underneath "BACK" to exit the Restore Factory Defaults menu.</p>	

Factory Default User Settings

TEMPERATURES MENU	DEFAULT SETTING	ADJUSTABLE RANGE
Operating Set Point	120°F (49°C)	90°F to 190°F (32°C to 88°C)
Differential Settings	2°F (1°C)	1°F to 20°F (1°C to 11°C)
Tank Probe Offset	0°F (0°C)	-5°F to +5°F (-3°C to +3°C)
ECONOMY MODE SETUP MENU	DEFAULT SETTING	ADJUSTABLE RANGE
Setpoint Adjustment	20°F (11°C)	2°F to 50°F (1°C to 28°C)
Daily Operating Mode	Normal Operation All Day	See page 64
ALARM OUTPUT SETUP MENU	DEFAULT SETTING	ADJUSTABLE RANGE
Alarm Output Function	Disabled	See page 68
Alarm SP	100 (38°C)	90°F to 190°F (32°C to 88°C)
DISPLAY SETTINGS MENU	DEFAULT SETTING	ADJUSTABLE RANGE
Temperature Units	°Fahrenheit	°Fahrenheit or °Celsius
Backlight Delay	10 Seconds	Always off/on, 10, 30, 60 Sec
Contrast	30%	20% to 100%

TROUBLESHOOTING

COMMON SERVICE PROBLEMS

No Hot Water

- 1 Hot water supply valve to fixtures turned off; cold water supply valve to water heater turned off.
- 2 Check power to the water heater - see pages 12 - 14.
- 3 Check Operating Set Point and Differential Set Points - see pages 61 & 62.
- 4 Check all fuses - see page 15.
- 5 Check heating elements pages 23 - 30.
- 6 Ensure both enable/disable circuits at the CCB's J7 plug/socket connection are closed circuits. See CCB Enable/Disable Circuit(s) Test on page 53 and Heater Status Menu information on page 63.

Not Enough Hot Water

- 1 Water heater may be undersized.
- 2 Check Operating Set Point and Differential Set Points - see pages 61 & 62.
- 3 Ensure the time is set correctly (daylight savings etc) and ensure the water heater is not in the Economy Mode during peak demand periods - see pages 64 - 67.
- 4 Check power to the water heater (see pages 12 - 14) - ensure there is not a "dead leg" on water heaters configured for three phase (3Ø) power.
- 5 Ensure the power supply to the water heater matches the listed voltage on the water heater rating plate - see pages 12 - 14.
- 6 Check hot water supply piping for leaks or restrictions: lime/scale - valve partially closed.
- 7 Check all fuses - see page 15.
- 8 Check heating elements pages 23 - 30.
- 9 Check Contactors on - see pages 34 - 38.
- 10 Ensure both enable/disable circuits at the CCB's J7 socket are closed circuits. If either/both circuits are being used by a supervisory control(s) check that control's settings to ensure it is not disabling heating operation during occupied/normal demand periods. See CCB Enable/Disable Circuit(s) Test on page 53 and Heater Status Menu information on page 63.

Water Heater Trips Breaker

- 1 Ensure the power supply breaker/fusing to the water heater meets the minimum required fuse/wire/breaker sizing. See the listed voltage and amperage on the water heater rating plate - see pages 12 - 14.
- 2 Check for grounded heating elements - see page 30.
- 3 Check for pinched/shorted wiring - internal wiring or power supply wiring.

Contactors Chatter

Condition: contactors opening and closing rapidly.

- 1 Ensure the 120 VAC Control Circuit Transformer is properly configured to match the power supply to the water heater - see pages 39 & 40.
- 2 Ensure the power supply to the water heater matches the listed voltage on the water heater rating plate - see pages 12 - 14.
- 3 Ensure wiring connections at 120 VAC contactor coil(s) are secure and in good condition - see page 37.

CONTROL SYSTEM DIAGNOSTICS

Fault Conditions

When the control system declares a Fault condition it will display a Fault message on the UIM and lock out. Voltage to the contactor coils and heating elements is terminated to prevent further heating operation.

Alert Conditions

When the control system declares an Alert condition it will continue heating but will display an Alert message on the UIM notifying the user that the water heater requires servicing.

Resetting Control System

Turn the power supply to the water heater off for approximately 20 seconds and then back on. If the operational problem that caused the control system to declare a Fault or Alert condition has not been corrected the control system will continue to display the Alert or Fault message and lock out.

CONTROL SYSTEM UNRESPONSIVE

DISPLAYED MESSAGE CONDITION/INDICATES	CHECK/REPAIR
<p style="text-align: center;">UIM Display Is Blank</p> <p>UIM is not energized - LCD display is blank.</p> <p>Possible Causes:</p> <p>No power to water heater Blown control circuit transformer fuses 120 VAC power problems 24 VAC power problems Defective transformer(s) Wiring or plug/socket connection problems UIM communication cable problems</p> <p>Important Service Reminder:</p> <p>When performing any troubleshooting steps outlined in this service manual always consider the wiring and connectors between components. Perform a close visual inspection of all wiring and connectors to a given component before replacement.</p> <p>Ensure wires were stripped before being crimped in a wire connector, ensure wires are crimped tightly in their connectors. Ensure pins inside plugs/sockets are not damaged or worn, ensure plugs/sockets are mating properly & providing good contact.</p>	<ul style="list-style-type: none"> • Check/restore power supply to the water heater at Power Distribution Block - see pages 12 - 14. • Check control circuit transformer fuses see Figure 2 page 9 and checking fuses page 15. • Check communication cable connections at UIM's J2 Socket (page 55) and the CCB's J11 Port (page 50). • Install a new communication cable between UIM's J2 Socket and the CCB's J11 Port - use standard Cat 5 network cable. • Closely inspect communication ports on the CCB and UIM to ensure they are mating properly and providing good contact (pages 50 & 55). • Ensure 120 VAC power/ground is supplied to CCB's J2 Socket; follow procedure on page 54. • Check J1 and J2 plug/socket connections on the CCB - ensure they are mating properly and providing good contact (page 50). • Check 24 VAC transformer: follow procedure outlined on page 42. • Call the technical support phone number on the back cover of this manual for further assistance if the problem has not been corrected after performing the procedure outlined here.

Control System Unresponsive (cont)



DISPLAYED MESSAGE CONDITION/INDICATES	CHECK/REPAIR
<p style="text-align: center;">UIM is Inoperable</p> <p>UIM does not respond to any user input using the operational and/or Up and Down buttons.</p>	<ul style="list-style-type: none"> • Ensure Ribbon Cable from the Button overlay is inserted correctly in UIM J3 Socket (page 55). • Call the technical support phone number on the back cover of this manual for further assistance if the problem has not been corrected after performing the procedure outlined here.
<p style="text-align: center;">Heating Cycle Disabled</p> <p>Control System not activating call for heat with cold tank of water. Thermometer Icon on Desktop Screen (see page 58) appears with diagonal line as shown here.</p> <div style="display: flex; align-items: center; justify-content: center;"> <div style="margin-right: 20px;"> <p>Possible Causes: Fault condition active Enable/disable circuit(s) open</p> </div>  </div>	<ul style="list-style-type: none"> • Check for and correct any active Fault condition - see Current Fault Menu page 71. • Check enable/disable circuits - ensure both circuits are closed; follow procedure outlined on page 53. • Call the technical support phone number on the back cover of this manual for further assistance if the problem has not been corrected after performing the procedure outlined here.

FAULT AND ALERT MESSAGES

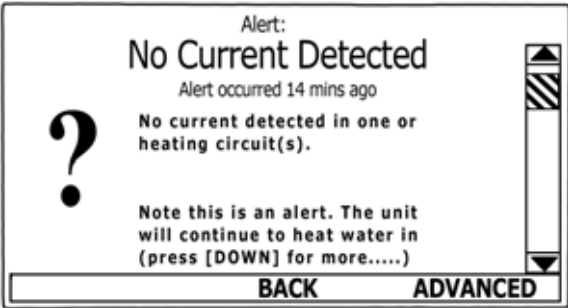
Troubleshooting procedures for the most common Fault and Alert messages are covered in this section. In the tables that follow the first column shows the Fault or Alert message as displayed by the UIM along with an explanation. The second column details things to check or repair and references test procedures detailed in the Operation and Service section (pages 10 - 55) of this manual.

DISPLAYED MESSAGE CONDITION/INDICATES	CHECK/REPAIR
<p style="text-align: center;">“No Current Detected” (Alert Condition)</p> <p>The control system has not detected current in one or more heating elements when expected.</p> <p>Possible Causes:</p> <p>Power supply problem (dead leg on 3 phase supply) Blown power circuit fuses Defective heating element(s) Defective contactor(s) Plug/socket connection problems Defective Element Sensor Wiring connection problems</p> 	<ul style="list-style-type: none"> • Ensure the power supply to the water heater matches the listed voltage on the water heater rating plate. Ensure there is not a dead leg of power on 3Ø models - see pages 12 - 14. • Check power circuit fuses - see page 15. • Check heating elements see pages 23 - 30. • Check contactors - see pages 34 - 38. • Check power circuit wiring to heating elements from Power Distribution Block (or contactor on single element models), to fuse blocks, to contactors, to heating elements - see wiring diagram on water heater and Contactor Configuration illustrations on page 35. Correct any mis wiring. Repair or replace damaged wiring as necessary. • Check the Element Sensor J12, J13, J14, J15 and J16 plug/socket connections at the CCB for wear or damage - see page 33. Ensure they are mating properly and providing good contact. See CCB illustration and socket identification on pages 50 - 52 for location. • Check Element Sensors - see pages 32 & 33. Replace any Element Sensors determined to be defective. • Call the toll free technical support phone number on the back cover of this manual for further assistance if the problem has not been corrected after performing the procedures outlined here.

Fault & Alert Messages

DISPLAYED MESSAGE CONDITION/INDICATES	CHECK/REPAIR
<p align="center">“Temp Probe Open” (Fault Condition)</p> <p>The control system has detected an open circuit from the temperature sensor. The control system will declare this Fault condition if it senses a resistance above 56,000 ohms from the temperature sensor.</p> <p>Possible Causes: Plug/socket connection problems Wiring connection problems Defective Immersion Temperature Probe</p> 	<ul style="list-style-type: none"> • Check the J5 plug/socket connections at the CCB ensure they are mating properly and providing good contact. Check the pins inside the J5 plug/socket for wear or damage. See CCB illustration and socket identification on pages 50 - 52. Replace damaged plug connectors/wiring harness as necessary. • Check for pinched or broken wiring between the Immersion Temperature Probe and the J5 plug/socket connection on the CCB - repair or replace damaged wiring as necessary. See CCB illustration and socket identification on pages 50 - 52. • Check the resistance of the temperature sensor inside the Immersion Temperature Probe - see pages 43 - 45. Replace the Immersion Temperature Probe if measured resistance is above 56,000 ohms. • Call the toll free technical support phone number on the back cover of this manual for further assistance if the problem has not been corrected after performing the procedures outlined here.
<p align="center">“Temp Probe Short” (Fault Condition)</p> <p>The control system has detected a shorted circuit in the temperature sensor. The control system will declare this Fault condition if it senses a resistance below 390 ohms from the temperature sensor.</p> <p>Possible Causes: Shorted wiring Defective Immersion Temperature Probe</p> 	<ul style="list-style-type: none"> • Check for pinched or shorted wires between the J5 plug/socket connection on the CCB and the Immersion Temperature Probe - repair or replace damaged wiring as necessary. See CCB illustration and socket identification on pages 50 - 52. • Check the resistance of the temperature sensor inside the Immersion Temperature Probe - see pages 43 - 45. Replace the Immersion Temperature Probe if measured resistance is below 390 ohms. • Call the toll free technical support phone number on the back cover of this manual for further assistance if the problem has not been corrected after performing the procedures outlined here.

Fault & Alert Messages

DISPLAYED MESSAGE CONDITION/INDICATES	CHECK/REPAIR
<p style="text-align: center;">“Energy Cut Out (ECO)” (Fault Condition)</p> <p>The control system has detected excessive water temperature inside the water heater. The ECO high temperature limit switch activates at 202°F/94°C. See ECO High Temperature Limit Switch description on page 43.</p> <p>Possible Causes: Plug/socket connection problems Wiring connection problems Contactor(s) stuck closed Contactor coils being energized in standby mode Defective Immersion Temperature Probe Water piping problems</p> <div data-bbox="228 898 794 1203" style="border: 1px solid black; padding: 5px; margin: 10px 0;"> </div>	<ul style="list-style-type: none"> • Check the J5 plug/socket connection at the CCB ensure they are mating properly and providing good contact. Check the pins inside the J5 plug/socket for wear or damage. See CCB illustration and socket identification on pages 50 - 52. Replace damaged plug connectors/wiring harness as necessary. • Check for pinched or broken wiring between the Immersion Temperature Probe and the J5 plug/socket connection on the CCB - repair or replace damaged wiring as necessary. See CCB illustration and socket identification on pages 50 - 52. • Check ECO continuity and for 120 VAC to and from the ECO - see pages 45 & 46. Replace Immersion Temperature Probe if ECO switch contacts remain open at normal operating temperatures. • Ensure the contactors are not stuck closed - see page 36. • Ensure the contactor coils are not being energized during standby mode - see pages 37 & 38. • Check water system piping; ensure heat is not being added to the water heater being serviced by any other heating appliances or heat sources. • Call the toll free technical support phone number on the back cover of this manual for further assistance if the problem has not been corrected after performing the procedures outlined here.

Fault & Alert Messages

DISPLAYED MESSAGE CONDITION/INDICATES	CHECK/REPAIR
<p style="text-align: center;">“LWCO Fault” (Fault Condition)</p> <p>The control system has detected a low water condition in the water heater’s storage tank - see page 47.</p> <p>Possible Causes: No water or low water in tank Water heater/CCB not properly grounded Plug/socket/wiring connection problems LWCO probe wiring shorted to ground Heavy calcium/lime accumulation on LWCO probe Defective LWCO probe</p> 	<ul style="list-style-type: none"> • Ensure the water heater is full of water. Follow the filling instructions in the maintenance section of Instruction Manual that came with the water heater. • Ensure the water heater is properly grounded - see grounding instructions in the Instruction Manual that came with the water heater and Grounding instructions on page 5 in this manual. • Ensure the CCB is properly grounded - see the Checking Power And Ground To The CCB tests on page 54. Ensure the ground wire leading from pin 2 of the J2 plug on the CCB (page 50) is securely connected to ground and the wire was properly stripped and crimped in it’s connector. • Check the J10 plug/socket connection at the CCB ensure they are mating properly and providing good contact. See CCB illustration and socket identification on pages 50 - 52. • Check for pinched/broken/shorted wiring between the LWCO probe and the J10 plug/socket connection on the CCB - repair or replace damaged wiring as necessary. See CCB illustration and socket identification on pages 50 - 52. • Remove the LWCO probe and inspect for damage and/or heavy calcium/lime accumulation clean and/or replace the LWCO probe as necessary - see page 47. • Call the toll free technical support phone number on the back cover of this manual for further assistance if the problem has not been corrected after performing the procedures outlined here.

Fault & Alert Messages

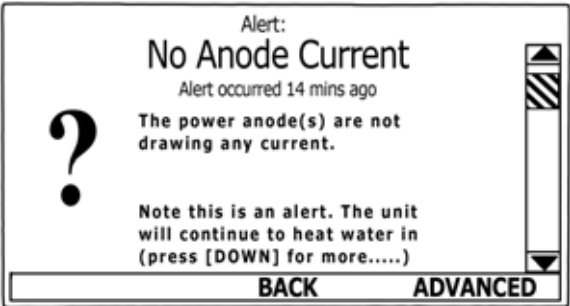
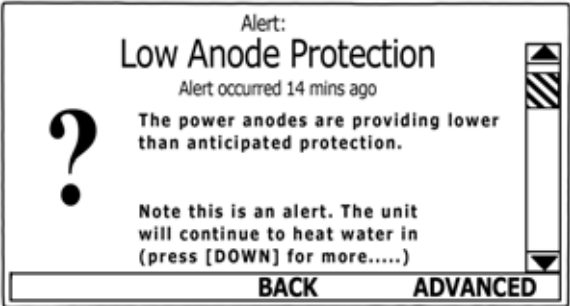
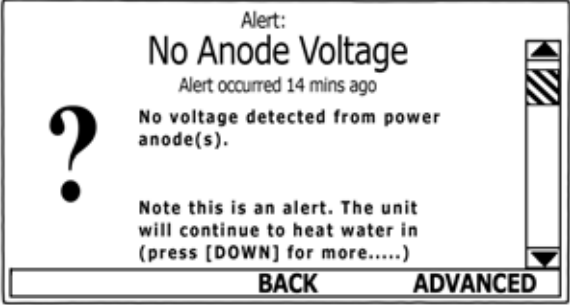
DISPLAYED MESSAGE CONDITION/INDICATES	CHECK/REPAIR
<p style="text-align: center;">“No Anode Current” “Low Anode Protection” “No Anode Voltage” (Alert Condition)</p> <p>The control system has detected one of three potential problems with the powered anode rod (on models so equipped) - see page 48.</p> <p>Possible Causes: No water or low water in tank Water heater/CCB not properly grounded Plug/socket/wiring connection problems Powered anode rod/wiring shorted to ground Heavy calcium/lime accumulation on anode Defective powered anode rod</p>   	<ul style="list-style-type: none"> • Ensure the water heater is full of water. Follow the filling instructions in the maintenance section of Instruction Manual that came with the water heater. • Ensure the water heater is properly grounded - see grounding instructions in the Instruction Manual that came with the water heater and Grounding instructions on page 5 in this manual. • Ensure the CCB is properly grounded - see the Checking Power And Ground To The CCB tests on page 54. Ensure the ground wire leading from pin 2 of the J2 plug on the CCB (page 50) is securely connected to ground and the wire was properly stripped and crimped in it's connector. • Check the J10 plug/socket connection at the CCB ensure they are mating properly and providing good contact. See CCB illustration and socket identification on pages 50 - 52. • Check for pinched/broken/shorted wiring between the Powered Anode Rod and the J10 plug/socket connection on the CCB - repair or replace damaged wiring as necessary. See CCB illustration and socket identification on pages 50 - 52. • Remove the powered anode and inspect for damage and/or heavy calcium/lime accumulation clean and/or replace anode as necessary - see page 48. • Call the toll free technical support phone number on the back cover of this manual for further assistance if the problem has not been corrected after performing the procedures outlined here.



500 Tennessee Waltz Parkway, Ashland City, TN 37015
Technical Support: 800-527-1953 • Parts: 800-433-2545 • Fax: 800-644-9306
www.hotwater.com